



**CREATIVE
CONCRETE**

Innovation in concrete since 1999

Product Range 2025



057 93 55808

Tullamore, Co. Offaly



**Irish Construction
Excellence Awards 2024
Winner**

**info@creativeconcrete.ie
WWW.CREATIVECONCRETE.IE**

Concrete Chambers Ireland Ltd T/A Creative Concrete

CONFIDENCE IN CONCRETE

Our products are manufactured to the highest standards at our strategically located manufacturing facility based in Tullamore , Co.Offaly .



[VIEW THE RANGE](#)



**Utility
Approved**



**Bespoke
Design**



**Superior
Quality**

What we do !

We pride ourselves in quality and customer service with over 25 years of expertise in the precast concrete manufacturing industry , distributing precast utility chambers nationwide .

SPECIALIST PRECAST UTILITY CHAMBERS

VISIT OUR WEBSITE:

WWW.CREATIVECONCRETE.IE

CONTACT US

+353 57 93 55808

All Products are manufactured in compliance with EN 1917:2002&AC:2008 Concrete Manholes and Inspection Chambers Un-Reinforced, Steel, Fibre, And Reinforced. Profiles, sizes, weights are given as an indication only. The manufacturer reserves the right to modify these at any time without notice.

TABLE OF CONTENTS



01

Uisce Éireann

A precast Chamber Range produced to the Uisce Éireann standards

02

Eir

Eir approved precast chambers produced to Eir Standards

03

ESB

ESB Approved precast Chambers produced to ESB Standards.

04

Public Lighting

A range of precast chamber regularly used for public lighting .

05

Virgin Media

Virgin Media approved precast chambers .

06

TII Chambers

A precast chamber range produced to TII Standard .

07

Bespoke Chambers

Our bespoke range of precast chambers made to order.

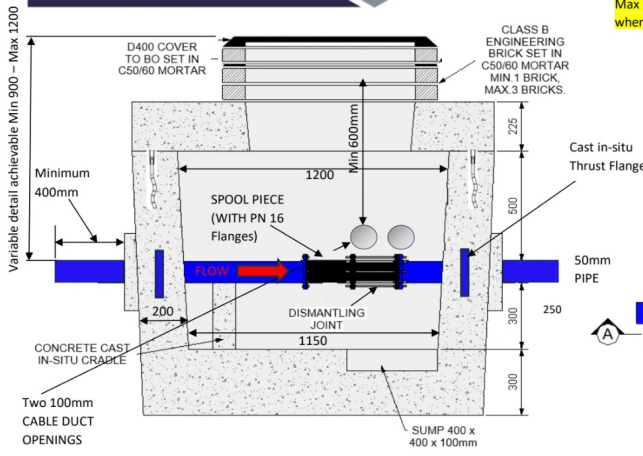

SECTION A-A: BULK WATER METER

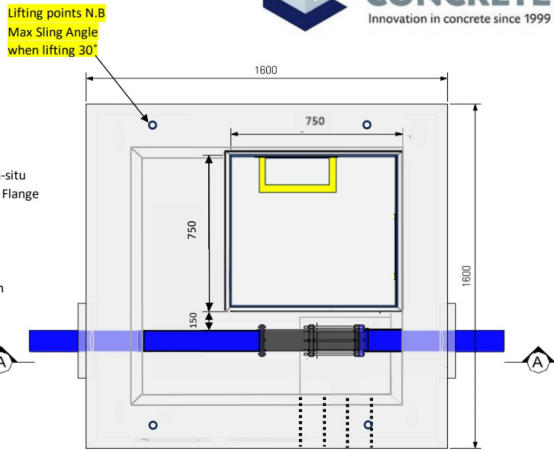

PLAN VIEW: BULK WATER METER

CONFIDENCE IN CONCRETE™

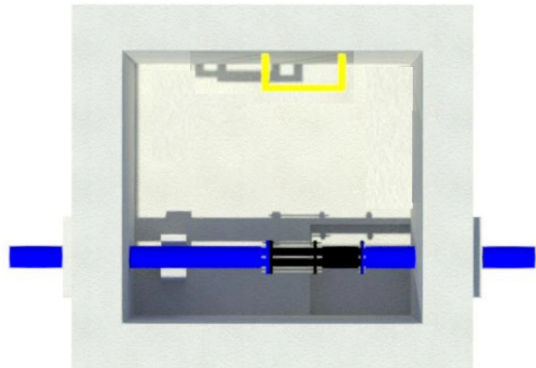
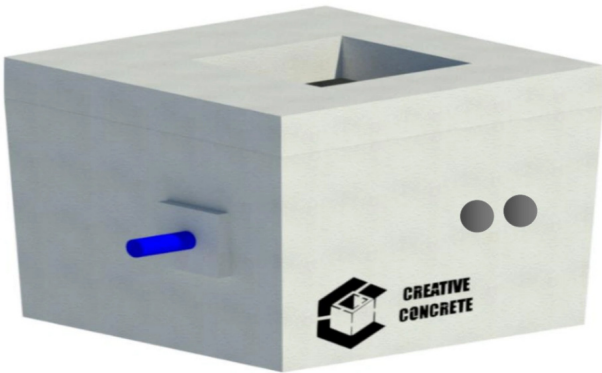

TECHNICAL DATA	
Mechanical Resistance	Vertical Strength 400kN
Chamber Approx Weight	4190KG
Cover Approx Weight	1140KG
Opening Size	(LN x WN) 1200mm, 1200mm Square
Watertightness	No Leakage of joint or unit at 30kPa
Durability	Adequate for normal serviceability conditions
Lifting Instructions	Max Sling Angle when lifting 30°

FEATURES	
Integrated Duct Openings	✓
Manufactured to the highest standards.	✓
Steel Reinforced	✓
Integrated Steps	✓
4 Integrated Lifting Sockets	✓
Integrated 50mm Pipe & Dismantling Joint	✓

All Products are manufactured in compliance with EN 1917:2002&AC:2008 Concrete Manholes and Inspection Chambers Un-Reinforced, Steel, Fibre, And Reinforced. The information contained in this TDS was up to date at time of going to print. Profiles, sizes, weights are given as an indication only. The manufacturer reserves the right to modify these at any time without notice.



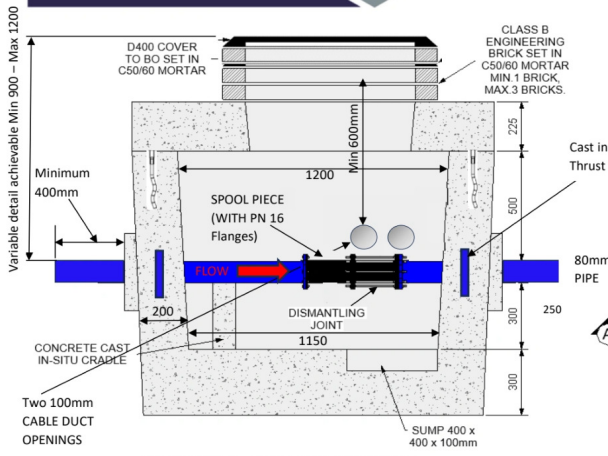

SECTION A-A: BULK WATER METER

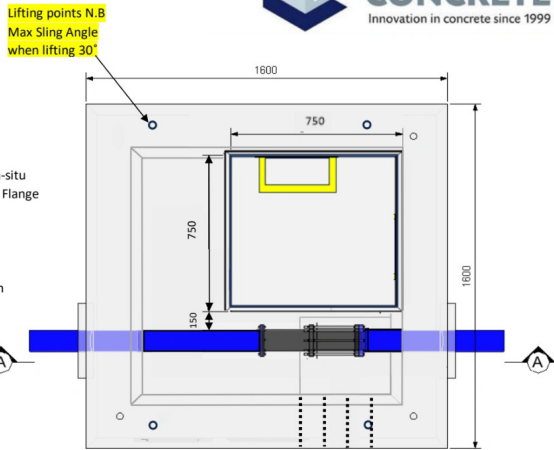

PLAN VIEW: BULK WATER METER

CONFIDENCE IN CONCRETE™

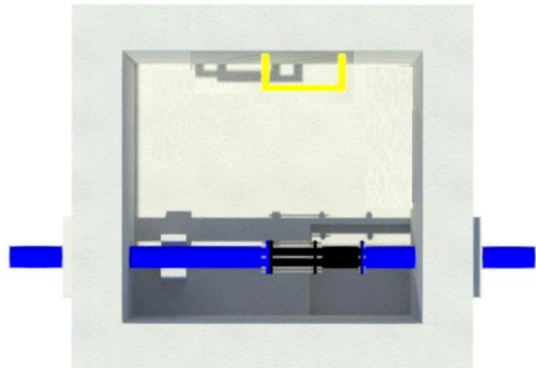
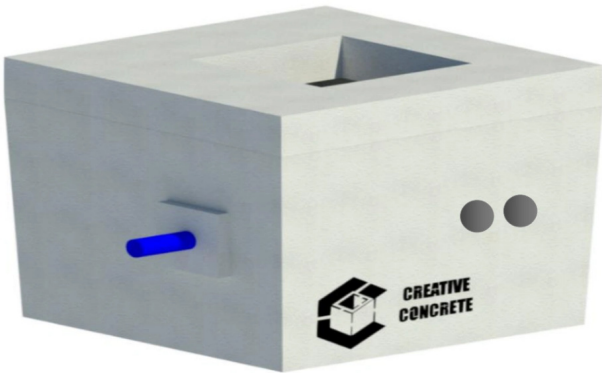

TECHNICAL DATA	
Mechanical Resistance	Vertical Strength 400kN
Chamber Approx Weight	4190KG
Cover Approx Weight	1140KG
Opening Size	(LN x WN) 1200mm, 1200mm Square
Watertightness	No Leakage of joint or unit at 30kPa
Durability	Adequate for normal serviceability conditions
Lifting Instructions	Max Sling Angle when lifting 30°

FEATURES	
Integrated Duct Openings	✓
Manufactured to the highest standards.	✓
Steel Reinforced	✓
Integrated Steps	✓
4 Integrated Lifting Sockets	✓
Integrated 80mm Pipe & Dismantling Joint	✓

All Products are manufactured in compliance with EN 1917:2002&AC:2008 Concrete Manholes and Inspection Chambers Un-Reinforced, Steel, Fibre, And Reinforced. The information contained in this TDS was up to date at time of going to print. Profiles, sizes, weights are given as an indication only. The manufacturer reserves the right to modify these at any time without notice.



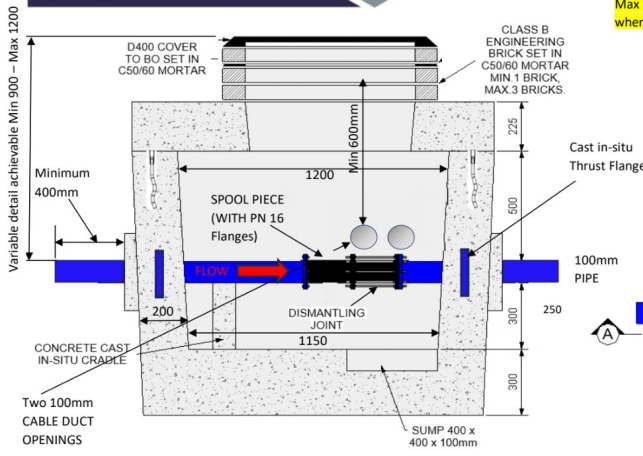

SECTION A-A: BULK WATER METER

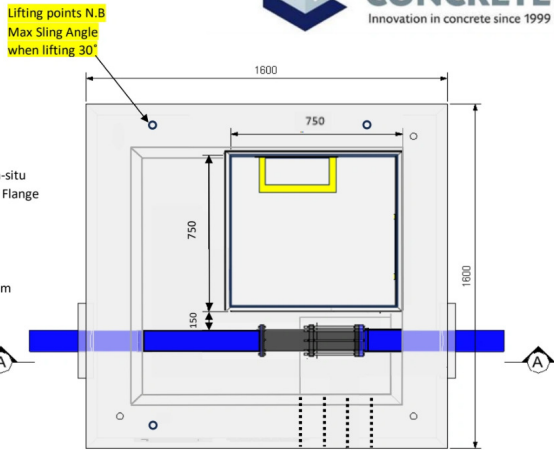

PLAN VIEW: BULK WATER METER

CONFIDENCE IN CONCRETE™

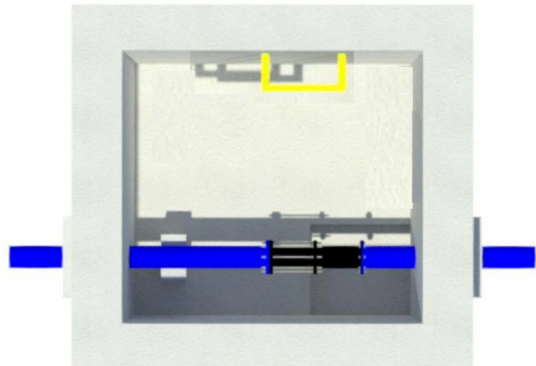
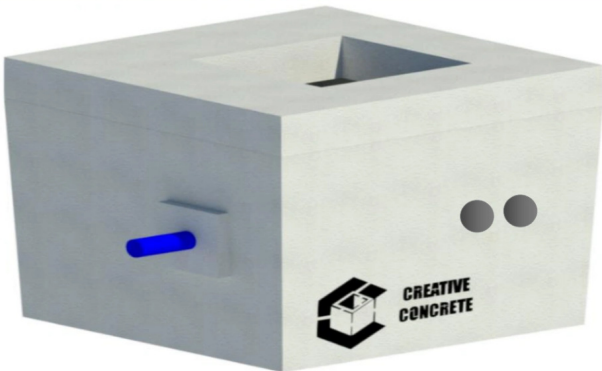

TECHNICAL DATA	
Mechanical Resistance	Vertical Strength 400kN
Chamber Approx Weight	4190KG
Cover Approx Weight	1140KG
Opening Size	(LN x WN) 1200mm, 1200mm Square
Watertightness	No Leakage of joint or unit at 30kPa
Durability	Adequate for normal serviceability conditions
Lifting Instructions	Max Sling Angle when lifting 30°

FEATURES	
Integrated Duct Openings	✓
Manufactured to the highest standards.	✓
Steel Reinforced	✓
Integrated Steps	✓
4 Integrated Lifting Sockets	✓
Integrated 100mm Pipe & Dismantling Joint	✓

All Products are manufactured in compliance with EN 1917:2002&AC:2008 Concrete Manholes and Inspection Chambers Un-Reinforced, Steel, Fibre, And Reinforced. The information contained in this TDS was up to date at time of going to print. Profiles, sizes, weights are given as an indication only. The manufacturer reserves the right to modify these at any time without notice.



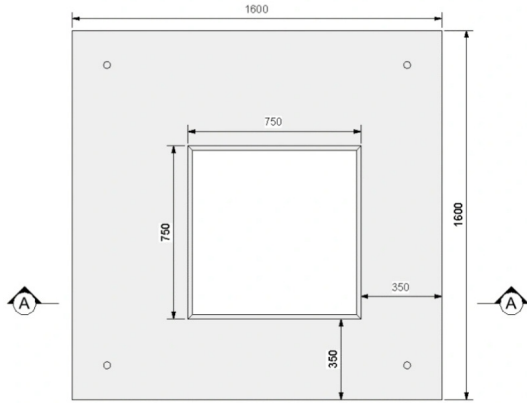

PLAN VIEW:

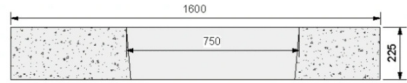

SECTION A-A:

CONFIDENCE IN CONCRETE™

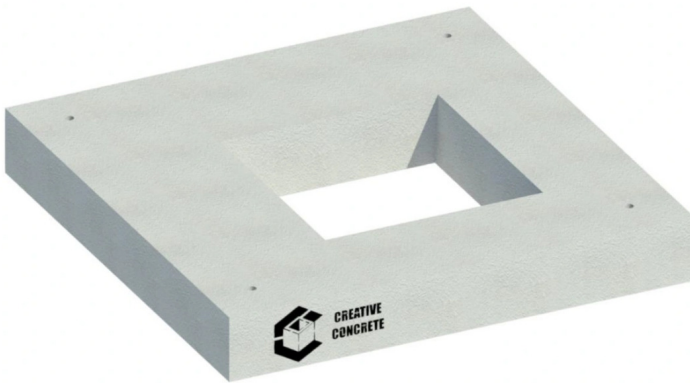

TECHNICAL DATA	
Mechanical Resistance	Vertical Strength 400kN
Approx Weight	1140KG
Opening Size	(LN x WN) 750mm, 750mm Rectangular
Watertightness	No Leakage of joint or unit at 30kPa
Durability	Adequate for normal serviceability conditions

FEATURES	
Integrated Opening	✓
Manufactured to the highest standards.	✓
Steel Reinforced	✓
Integrated Steps	✓
Integrated Lifting Sockets	✓
REV_05	

All Products are manufactured in compliance with EN 1917:2002&AC:2008 Concrete Manholes and Inspection Chambers Un-Reinforced, Steel, Fibre, And Reinforced. Profiles, sizes, weights are given as an indication only. The manufacturer reserves the right to modify these at any time without notice.

Concrete Chambers Ireland Ltd T/A Creative Concrete





CREATIVE CONCRETE
Innovation in concrete since 1999

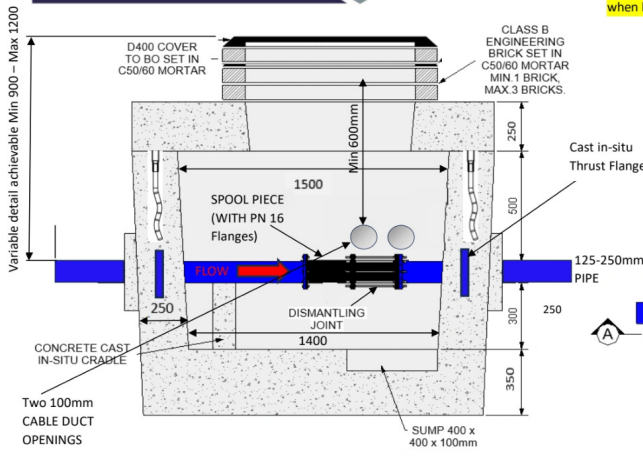

SECTION A-A: BULK WATER METER

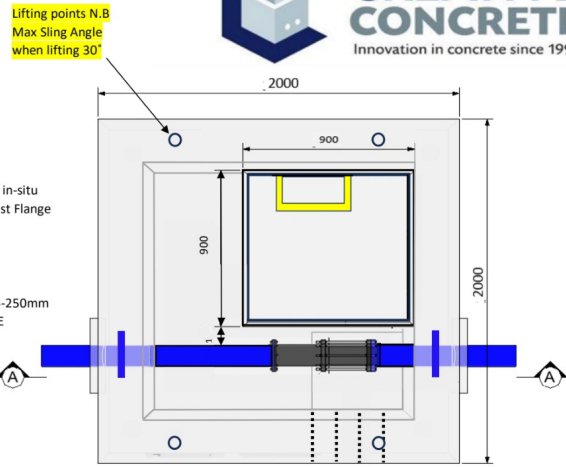

PLAN VIEW: BULK WATER METER

CONFIDENCE IN CONCRETE™

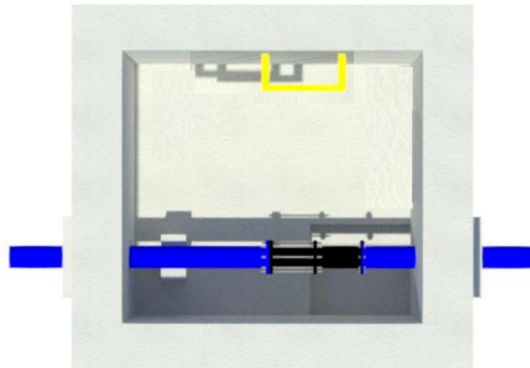
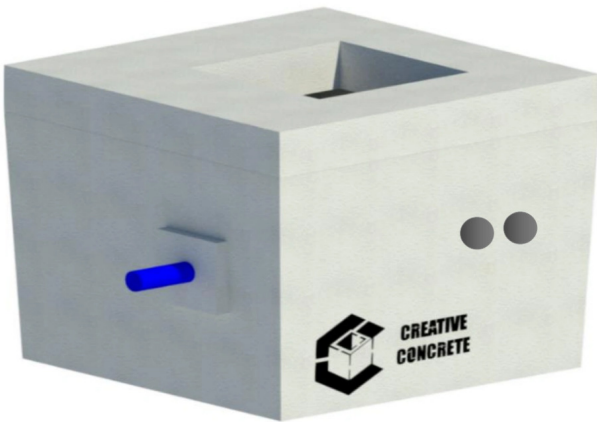

TECHNICAL DATA	
Mechanical Resistance	Vertical Strength 400kN
Chamber Approx Weight	7300KG
Cover Approx Weight	1900KG
Opening Size	(LN x WN) 1500mm, 1500mm Square
Watertightness	No Leakage of joint or unit at 30kPa
Durability	Adequate for normal serviceability conditions
Lifting Instructions	Max Sling Angle when lifting 30°

FEATURES	
Integrated Duct Openings	✓
Manufactured to the highest standards.	✓
Steel Reinforced	✓
Integrated Steps	✓
4 Integrated Lifting Sockets	✓
Integrated Pipe 125 - 250 & Dismantling Joint	✓

All Products are manufactured in compliance with EN 1917:2002&AC:2008 Concrete Manholes and Inspection Chambers Un-Reinforced, Steel, Fibre, And Reinforced. The information contained in this TDS was up to date at time of going to print. Profiles, sizes, weights are given as an indication only. The manufacturer reserves the right to modify these at any time without notice.



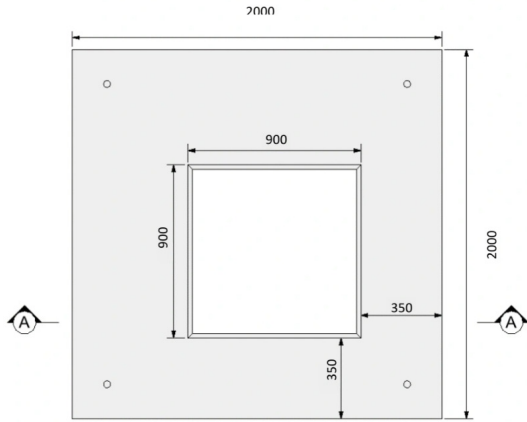

PLAN VIEW:

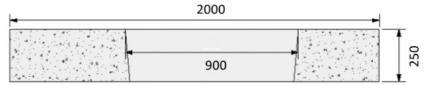

SECTION A-A:

CONFIDENCE IN CONCRETE™

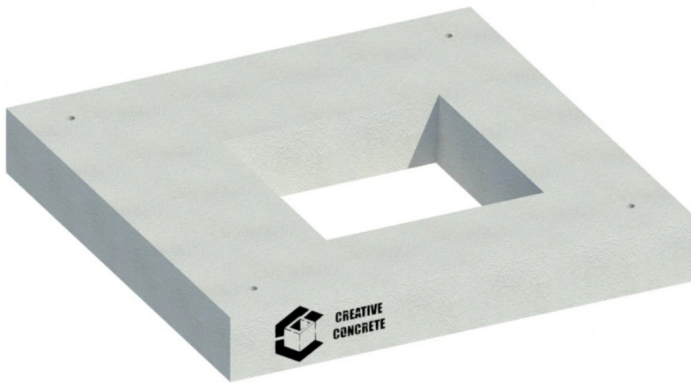

TECHNICAL DATA	
Mechanical Resistance	Vertical Strength 400kN
Approx Weight	1900KG
Opening Size	(LN x WN) 900mm, 900mm Square
Watertightness	No Leakage of joint or unit at 30kPa
Durability	Adequate for normal serviceability conditions

FEATURES	
Integrated Opening	✓
Manufactured to the highest standards.	✓
Steel Reinforced	✓
Integrated Steps	✓
Integrated Lifting Sockets	✓
REV_05	

All Products are manufactured in compliance with EN 1917:2002&AC:2008 Concrete Manholes and Inspection Chambers Un-Reinforced, Steel, Fibre, And Reinforced. Profiles, sizes, weights are given as an indication only. The manufacturer reserves the right to modify these at any time without notice.

Concrete Chambers Ireland Ltd T/A Creative Concrete



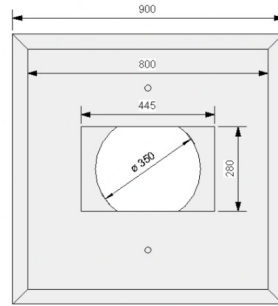
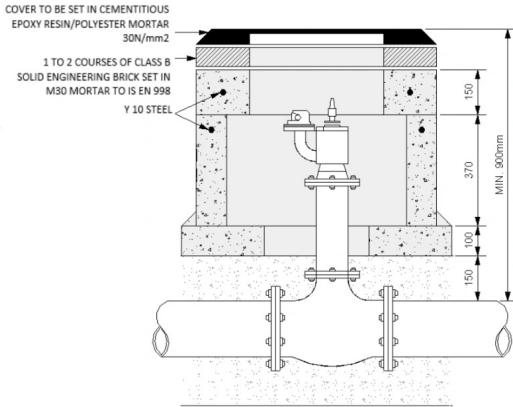

PLAN VIEW WITH COVER
OPENING 445 X 280MM

CONFIDENCE IN CONCRETE™

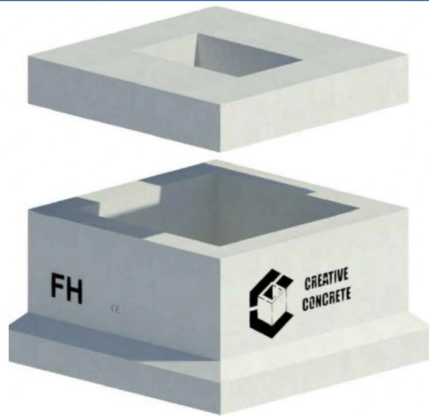

TECHNICAL DATA	
Mechanical Resistance	Vertical Strength 400kN
Chamber Approx Weight	440KG
Cover Approx Weight	195KG
Chamber Opening Size	(LN x WN) 600mm, 600mm Square
Watertightness	No Leakage of joint or unit at 30kPa
Durability	Adequate for normal serviceability conditions

FEATURES	
Integrated Base Opening	✓
Manufactured to the highest standards.	✓
Steel Reinforced	✓
Integrated Steps	
Integrated Lifting Sockets	✓
REV_05	

All Products are manufactured in compliance with EN 1917:2002&AC:2008 Concrete Manholes and Inspection Chambers Un-Reinforced, Steel, Fibre, And Reinforced. Profiles, sizes, weights are given as an indication only. The manufacturer reserves the right to modify these at any time without notice.

Concrete Chambers Ireland Ltd T/A Creative Concrete





**CREATIVE
CONCRETE**
Innovation in concrete since 1999

COVER TO BE SET IN CEMENTITIOUS
EPOXY RESIN/POLYESTER MORTAR
30N/mm²
1 TO 2 COURSES OF CLASS B
SOLID ENGINEERING BRICK SET IN
M30 MORTAR TO IS EN 998
Y 10 STEEL

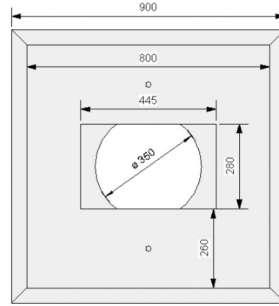
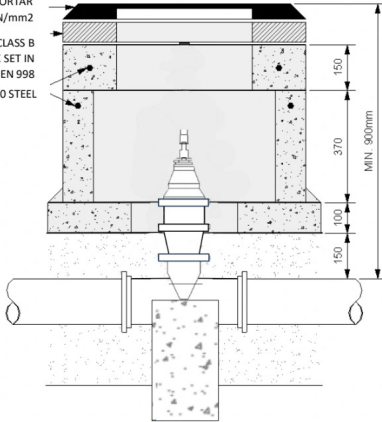

PLAN VIEW WITH COVER
OPENING 445 X 280MM

CONFIDENCE IN CONCRETE™

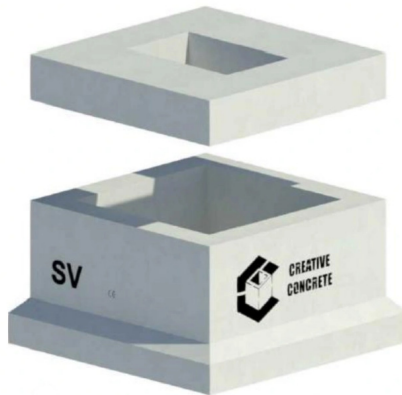

TECHNICAL DATA	
Mechanical Resistance	Vertical Strength 400kN
Approx Chamber Weight	440KG
Approx Cover Weight	195KG
Opening Size	(LN x WN) 600mm, 600mm Square
Watertightness	No Leakage of joint or unit at 30kPa
Durability	Adequate for normal serviceability conditions

FEATURES	
Integrated Base Opening	✓
Manufactured to the highest standards	✓
Steel Reinforced	✓
Integrated Steps	
Integrated Lifting Sockets	✓
REV_05	

All Products are manufactured in compliance with EN 1917:2002&AC:2008 Concrete Manholes and Inspection Chambers Un-Reinforced, Steel, Fibre, And Reinforced. Profiles, sizes, weights are given as an indication only. The manufacturer reserves the right to modify these at any time without notice.

Concrete Chambers Ireland Ltd T/A Creative Concrete





CREATIVE CONCRETE
Innovation in concrete since 1999

COVER TO BE SET IN CEMENTITIOUS
EPOXY RESIN/POLYESTER MORTAR
30N/mm²

1 TO 2 COURSES OF CLASS B
SOLID ENGINEERING BRICK SET IN
M30 MORTAR TO IS EN 998

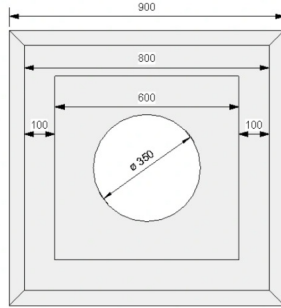
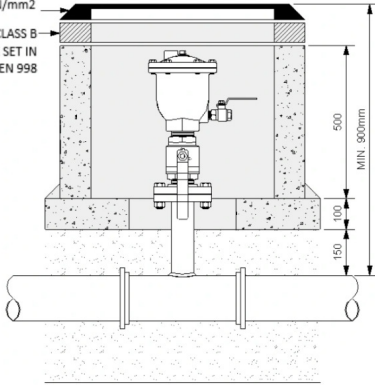

CONFIDENCE IN CONCRETE™

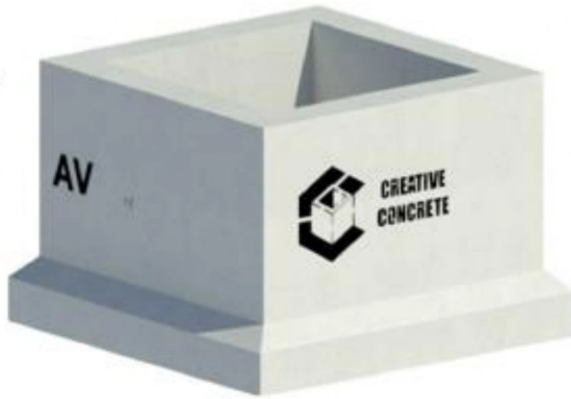

TECHNICAL DATA	
Mechanical Resistance	Vertical Strength 400kN
Approx Weight	530KG
Opening Size	(LN x WN) 600mm, 600mm Square
Watertightness	No Leakage of joint or unit at 30kPa
Durability	Adequate for normal serviceability conditions

FEATURES	
Integrated Base Opening	✓
Manufactured to the highest standards.	✓
Steel Reinforced	✓
Integrated Steps	
Integrated Lifting Sockets	✓
REV_05	

All Products are manufactured in compliance with EN 1917:2002&AC:2008 Concrete Manholes and Inspection Chambers Un-Reinforced, Steel, Fibre, And Reinforced. Profiles, sizes, weights are given as an indication only. The manufacturer reserves the right to modify these at any time without notice.

Concrete Chambers Ireland Ltd T/A Creative Concrete



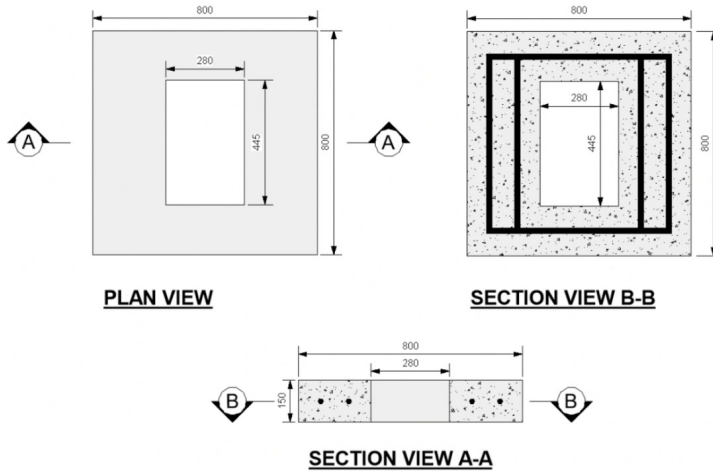

CONFIDENCE IN CONCRETE™

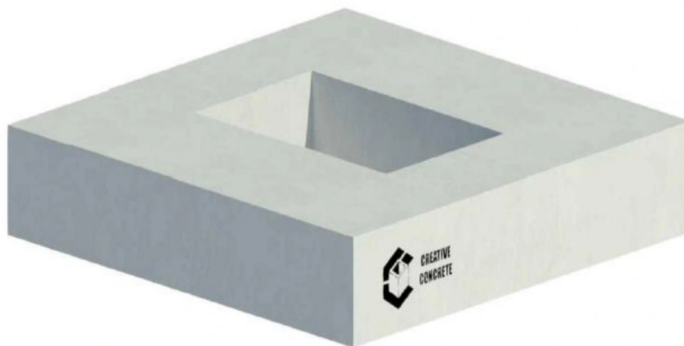

TECHNICAL DATA	
Mechanical Resistance	Vertical Strength 400kN
Approx Weight	195KG
Opening Size	(LN x WN) 445mm, 280mm Rectangular
Watertightness	No Leakage of joint or unit at 30kPa
Durability	Adequate for normal serviceability conditions

FEATURES	
Integrated Opening	✓
Manufactured to the highest standards.	✓
Steel Reinforced	✓
Integrated Steps	
Integrated Lifting Sockets	✓
REV_05	

All Products are manufactured in compliance with EN 1917:2002&AC:2008 Concrete Manholes and Inspection Chambers Un-Reinforced, Steel, Fibre, And Reinforced. Profiles, sizes, weights are given as an indication only. The manufacturer reserves the right to modify these at any time without notice.

Concrete Chambers Ireland Ltd T/A Creative Concrete





**CREATIVE
CONCRETE**
Innovation in concrete since 1999

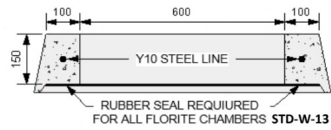
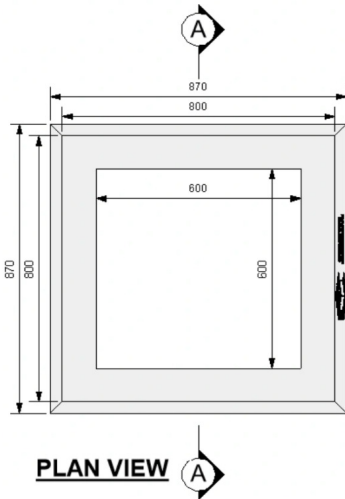

CONFIDENCE IN CONCRETE™



TECHNICAL DATA	
Mechanical Resistance	Vertical Strength 400kN
Approx Weight	125KG
Opening Size	(LN x WN) 600mm, 600mm Square
Watertightness	No Leakage of joint or unit at 30kPa
Durability	Adequate for normal serviceability conditions

FEATURES	
Universal with Various Chambers	✓
Manufactured to the highest standards	✓
Steel Reinforced	✓
Integrated Opening	✓
Integrated Lifting Sockets	✓
REV_05	

All Products are manufactured in compliance with EN 1917:2002&AC:2008 Concrete Manholes and Inspection Chambers Un-Reinforced, Steel, Fibre, And Reinforced. Profiles, sizes, weights are given as an indication only. The manufacturer reserves the right to modify these at any time without notice. **Concrete Chambers Ireland Ltd T/A Creative Concrete**





CREATIVE CONCRETE
 Innovation in concrete since 1999

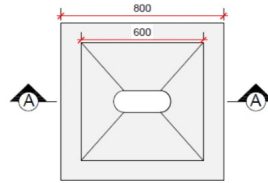
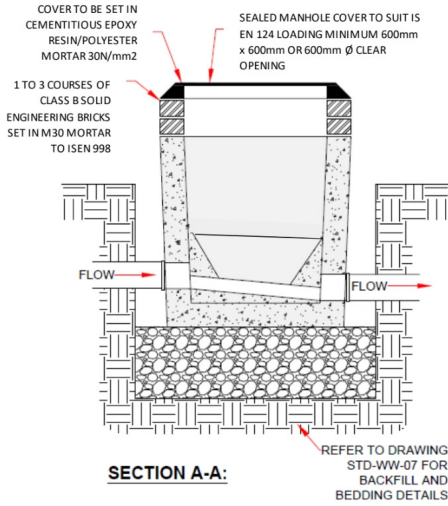

PLAN VIEW:

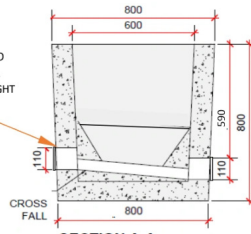

SECTION A-A:

CONFIDENCE IN CONCRETE™

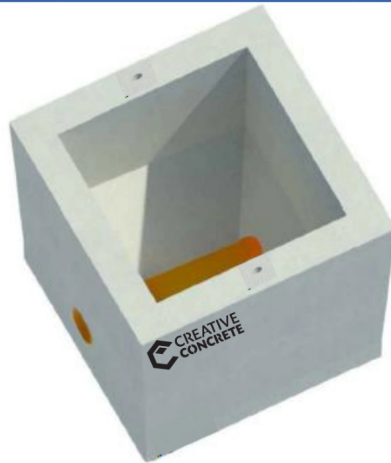

TECHNICAL DATA	
Mechanical Resistance	Vertical Strength 400kN
Approx Weight	770KG
Opening Size	(LN x WN) 600mm, 600mm Square
Watertightness	No Leakage of joint or unit at 30kPa
Durability	Adequate for normal serviceability conditions

FEATURES	
Integrated Duct Openings 110/160	✓
Manufactured to the highest standards.	✓
Steel Reinforced	
Integrated Steps	
Integrated Lifting Sockets	✓
REV_05	

All Products are manufactured in compliance with EN 1917:2002&AC:2008 Concrete Manholes and Inspection Chambers Un-Reinforced, Steel, Fibre, And Reinforced. Profiles, sizes, weights are given as an indication only. The manufacturer reserves the right to modify these at any time without notice.

Concrete Chambers Ireland Ltd T/A Creative Concrete





CREATIVE CONCRETE
 Innovation in concrete since 1999

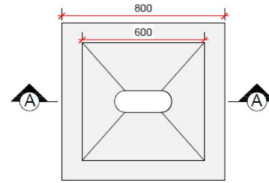
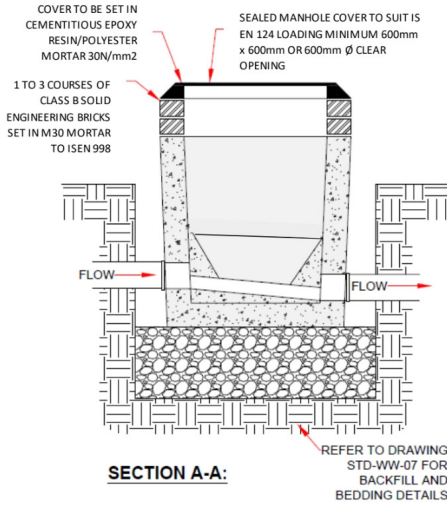

PLAN VIEW:

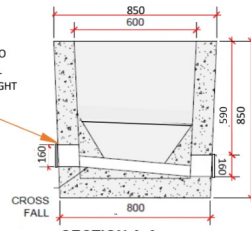

SECTION A-A:

CONFIDENCE IN CONCRETE™

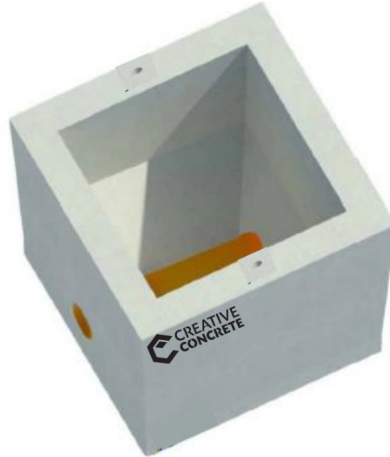

TECHNICAL DATA	
Mechanical Resistance	Vertical Strength 400kN
Approx Weight	770KG
Opening Size	(LN x WN) 600mm, 600mm Square
Watertightness	No Leakage of joint or unit at 30kPa
Durability	Adequate for normal serviceability conditions

FEATURES	
Integrated Duct Openings 160	✓
Manufactured to the highest standards.	✓
Steel Reinforced	
Integrated Steps	
Integrated Lifting Sockets	✓
REV_05	

All Products are manufactured in compliance with EN 1917:2002&AC:2008 Concrete Manholes and Inspection Chambers Un-Reinforced, Steel, Fibre, And Reinforced. Profiles, sizes, weights are given as an indication only. The manufacturer reserves the right to modify these at any time without notice.

Concrete Chambers Ireland Ltd T/A Creative Concrete



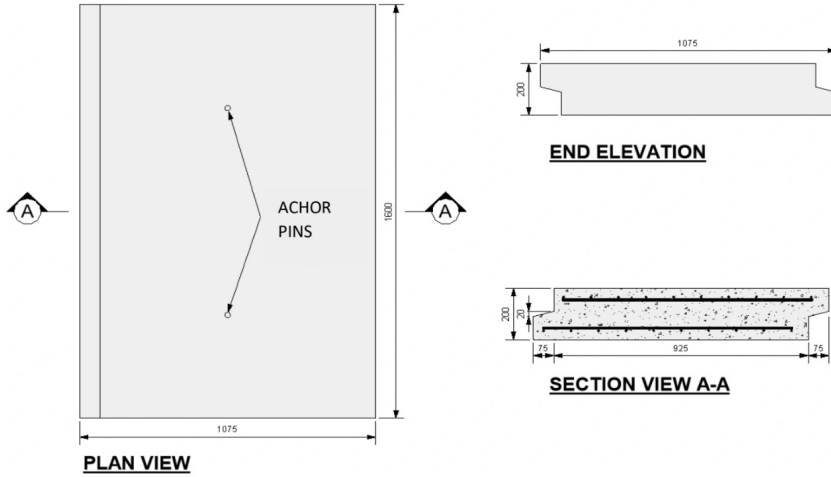

CONFIDENCE IN CONCRETE™

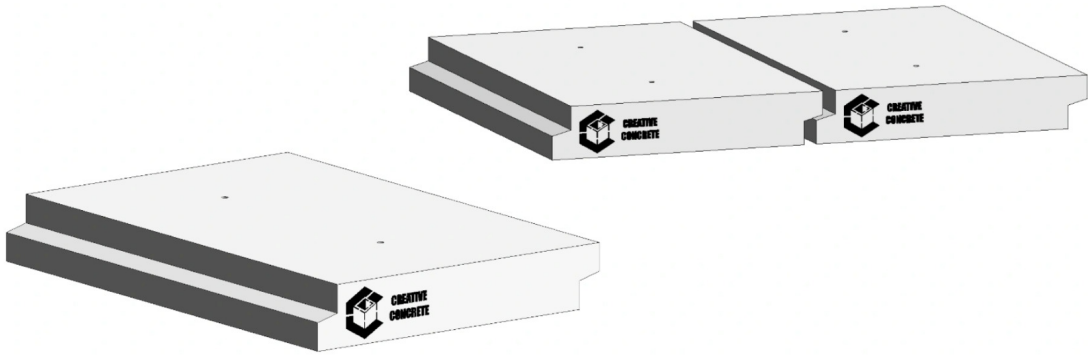

TECHNICAL DATA	
Mechanical Resistance	Vertical Strength 400kN
Approx Weight	750KG
Watertightness	No Leakage of joint or unit at 30kPa
Durability	Adequate for normal serviceability conditions

FEATURES	
Integrated Base Opening	
Manufactured to the highest standards.	✓
Steel Reinforced	✓
Integrated Steps	
Integrated Anchor pins	✓
REV_05	

All Products are manufactured in compliance with EN 1917:2002&AC:2008 Concrete Manholes and Inspection Chambers Un-Reinforced, Steel, Fibre, And Reinforced. Profiles, sizes, weights are given as an indication only. The manufacturer reserves the right to modify these at any time without notice.

Concrete Chambers Ireland Ltd T/A Creative Concrete





**CREATIVE
CONCRETE**
Innovation in concrete since 1999

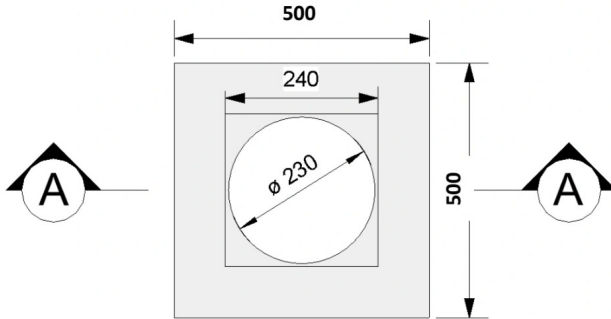

PLAN VIEW

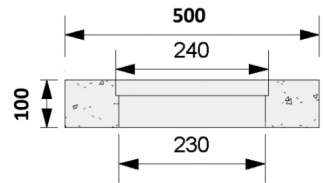

SECTION VIEW A-A

CONFIDENCE IN CONCRETE™

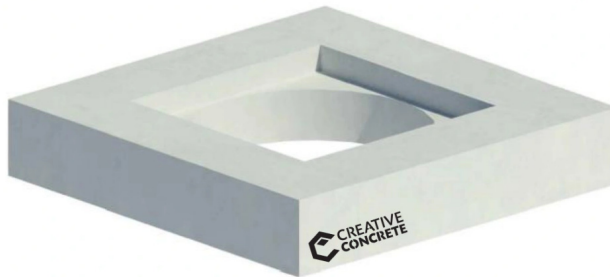

TECHNICAL DATA	
Mechanical Resistance	Vertical Strength 400kN
Approx Weight	40 KG
Opening Size	Ø230
Watertightness	No Leakage of joint or unit at 30kPa
Durability	Adequate for normal serviceability conditions

FEATURES	
Integrated Base Opening	✓
Manufactured to the highest standards.	✓
Steel Reinforced	✓
Integrated Steps	
Integrated Lifting Sockets	
REV_05	

All Products are manufactured in compliance with EN 1917:2002&AC:2008 Concrete Manholes and Inspection Chambers Un-Reinforced, Steel, Fibre, And Reinforced. Profiles, sizes, weights are given as an indication only. The manufacturer reserves the right to modify these at any time without notice.

Concrete Chambers Ireland Ltd T/A Creative Concrete





**CREATIVE
CONCRETE**
Innovation in concrete since 1999

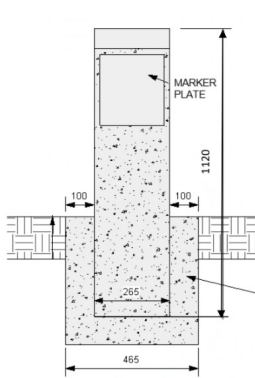

SECTION A-A: MARKER POST COMPLETE WITH CONCRETE SURROUND

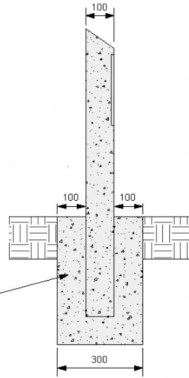

SECTION B-B: MARKER POST COMPLETE WITH CONCRETE SURROUND

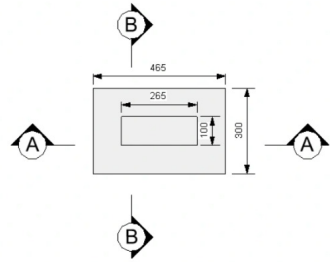

PLAN VIEW: MARKER POST COMPLETE WITH CONCRETE SURROUND

CONFIDENCE IN CONCRETE™

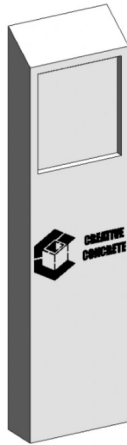

TECHNICAL DATA	
Mechanical Resistance	Vertical Strength 400kN
Weight	70KG
Watertightness	No Leakage of joint or unit at 30kPa
Durability	Adequate for normal serviceability conditions

FEATURES	
Integrated Duct Openings	
Manufactured to the highest standards.	✓
Steel Reinforced	✓
Integrated Steps	
Integrated Lifting Sockets	
REV_06	

All Products are manufactured in compliance with EN 1917:2002&AC:2008 Concrete Manholes and Inspection Chambers Un-Reinforced, Steel, Fibre, And Reinforced. Profiles, sizes, weights are given as an indication only. The manufacturer reserves the right to modify these at any time without notice.

Concrete Chambers Ireland Ltd T/A Creative Concrete





CREATIVE CONCRETE
Innovation in concrete since 1999

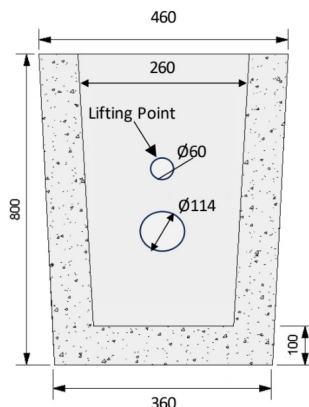
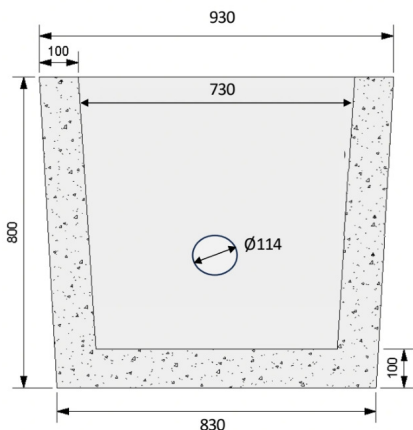

CONFIDENCE IN CONCRETE™

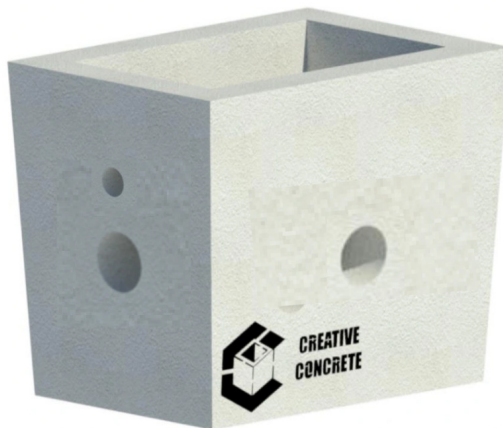

TECHNICAL DATA	
Mechanical Resistance	Vertical Strength 400kN
Approx Weight	484KG
Opening Size	(LN x WN) 730mm, 260mm Rectangular
Watertightness	No Leakage of joint or unit at 30kPa
Durability	Adequate for normal serviceability conditions

FEATURES	
Integrated Duct Openings	✓
Manufactured to the highest standards.	✓
Steel Reinforced	
Integrated Steps	
Integrated Lifting Sockets	
REV_02	

All Products are manufactured in compliance with EN 1917:2002&AC:2008 Concrete Manholes and Inspection Chambers Un-Reinforced, Steel, Fibre, And Reinforced. Profiles, sizes, weights are given as an indication only. The manufacturer reserves the right to modify these at any time without notice.

Concrete Chambers Ireland Ltd T/A Creative Concrete



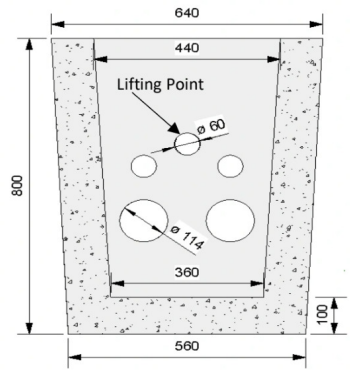
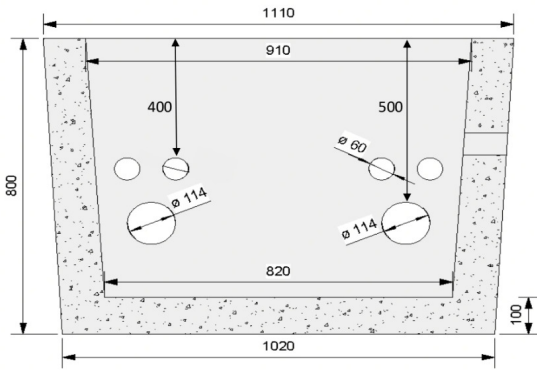

CONFIDENCE IN CONCRETE™

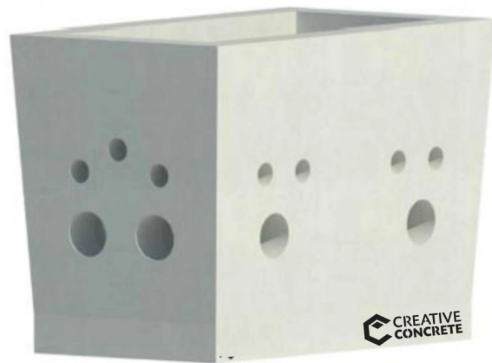

TECHNICAL DATA	
Mechanical Resistance	Vertical Strength 400kN
Approx Weight	600KG
Opening Size	(LN x WN) 910mm, 440mm Rectangular
Watertightness	No Leakage of joint or unit at 30kPa
Durability	Adequate for normal serviceability conditions

FEATURES	
Integrated Duct Openings	✓
Manufactured to the highest standards.	✓
Steel Reinforced	
Integrated Steps	
Integrated Lifting Sockets	
REV_05	

All Products are manufactured in compliance with EN 1917:2002&AC:2008 Concrete Manholes and Inspection Chambers Un-Reinforced, Steel, Fibre, And Reinforced. Profiles, sizes, weights are given as an indication only. The manufacturer reserves the right to modify these at any time without notice.

Concrete Chambers Ireland Ltd T/A Creative Concrete





CREATIVE CONCRETE
Innovation in concrete since 1999

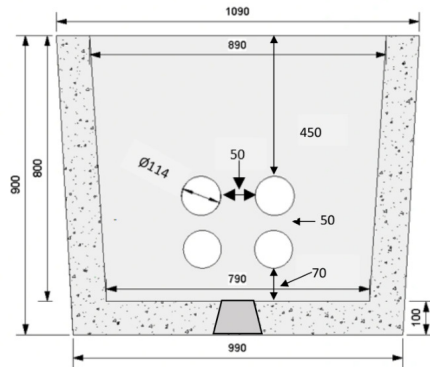
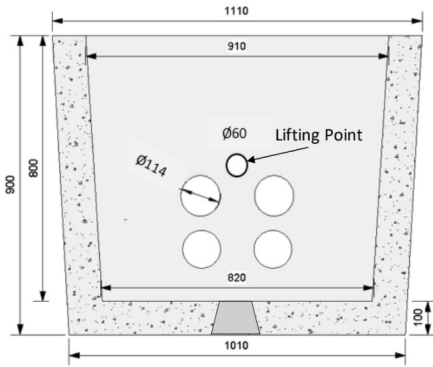

CONFIDENCE IN CONCRETE™

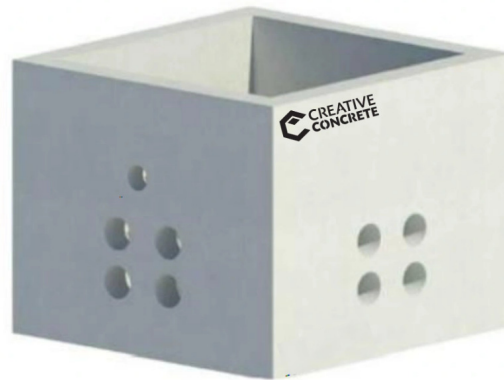

TECHNICAL DATA	
Mechanical Resistance	Vertical Strength 400kN
Approx Weight	940KG
Opening Size	(LN x WN) 910mm, 890mm Rectangular
Watertightness	No Leakage of joint or unit at 30kPa
Durability	Adequate for normal serviceability conditions

FEATURES	
Integrated Duct Openings	✓
Manufactured to the highest standards.	✓
Steel Reinforced	✓
Integrated Steps	
Integrated Lifting Sockets	✓
REV_05	

All Products are manufactured in compliance with EN 1917:2002&AC:2008 Concrete Manholes and Inspection Chambers Un-Reinforced, Steel, Fibre, And Reinforced. Profiles, sizes, weights are given as an indication only. The manufacturer reserves the right to modify these at any time without notice.

Concrete Chambers Ireland Ltd T/A Creative Concrete





CREATIVE CONCRETE
Innovation in concrete since 1999

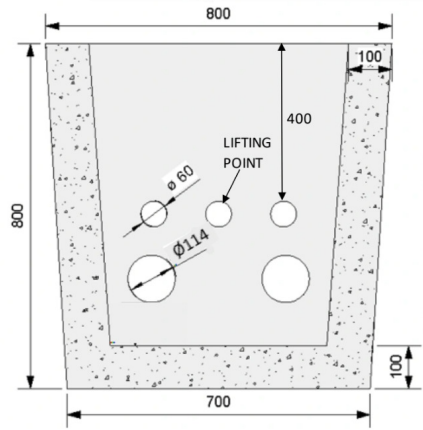
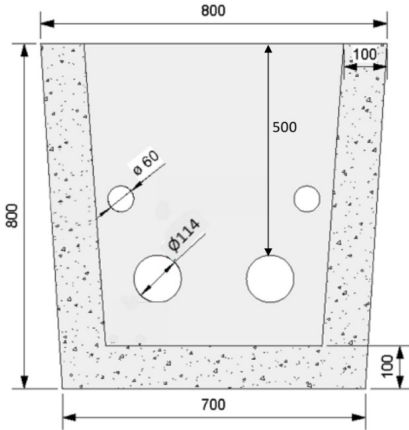

CONFIDENCE IN CONCRETE™

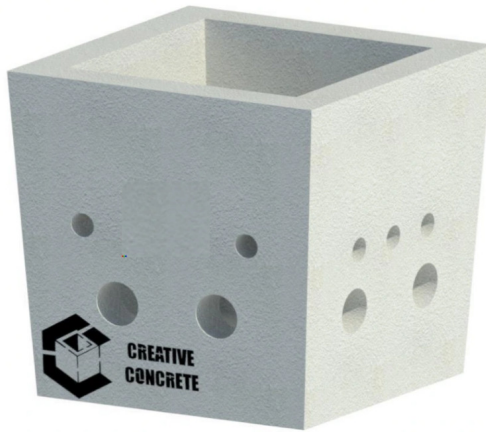

TECHNICAL DATA	
Mechanical Resistance	Vertical Strength 400kN
Approx Weight	530KG
Opening Size	(LN x WN) 600mm, 600mm Square
Watertightness	No Leakage of joint or unit at 30kPa
Durability	Adequate for normal serviceability conditions

FEATURES	
Integrated Duct Openings	✓
Manufactured to the highest standards.	✓
Steel Reinforced	
Integrated Steps	
Integrated Lifting Sockets	
REV_05	

All Products are manufactured in compliance with EN 1917:2002&AC:2008 Concrete Manholes and Inspection Chambers Un-Reinforced, Steel, Fibre, And Reinforced. Profiles, sizes, weights are given as an indication only. The manufacturer reserves the right to modify these at any time without notice.

Concrete Chambers Ireland Ltd T/A Creative Concrete





CREATIVE CONCRETE
Innovation in concrete since 1999

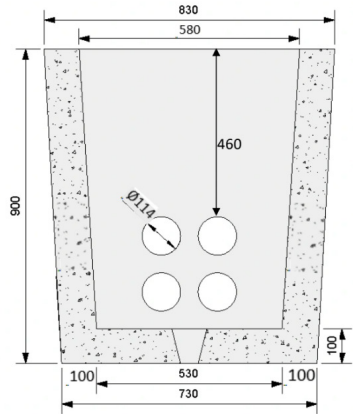
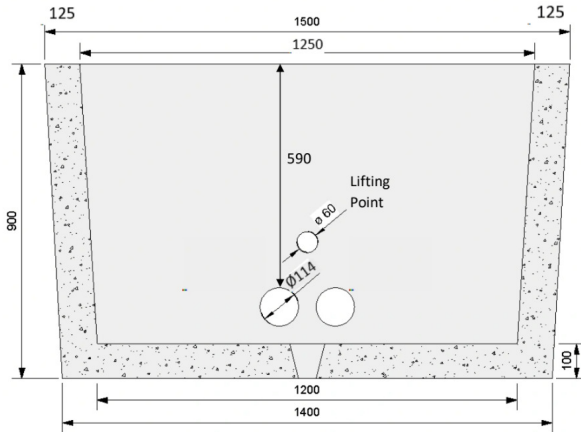

CONFIDENCE IN CONCRETE™

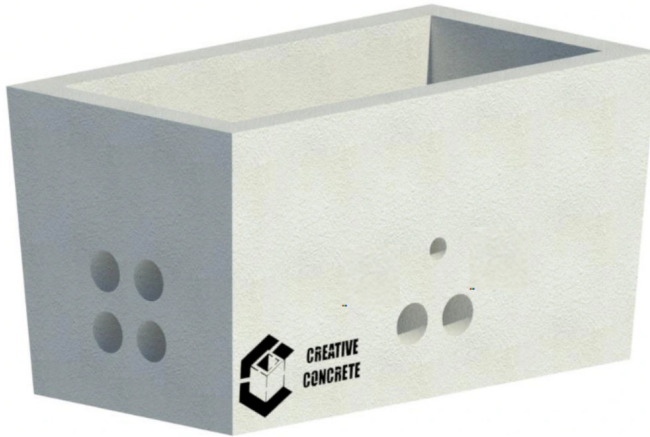

TECHNICAL DATA	
Mechanical Resistance	Vertical Strength 400kN
Approx Weight	950KG
Opening Size	(LN x WN) 1250mm, 580mm Rectangular
Watertightness	No Leakage of joint or unit at 30kPa
Durability	Adequate for normal serviceability conditions

FEATURES	
Integrated Duct Openings	✓
Manufactured to the highest standards.	✓
Steel Reinforced	
Integrated Steps	
Integrated Lifting Sockets	
REV_05	

All Products are manufactured in compliance with EN 1917:2002&AC:2008 Concrete Manholes and Inspection Chambers Un-Reinforced, Steel, Fibre, And Reinforced. Profiles, sizes, weights are given as an indication only. The manufacturer reserves the right to modify these at any time without notice.

Concrete Chambers Ireland Ltd T/A Creative Concrete





**CREATIVE
CONCRETE**

Innovation in concrete since 1999



ESB Approved Precast Supplier



**Irish Construction
Excellence Awards 2024
Winner**

**Ballinamere,
Tullamore, Co.Offaly.
057 93 55808**



CREATIVE CONCRETE
Innovation in concrete since 1999

VC 2 Cover & Frame

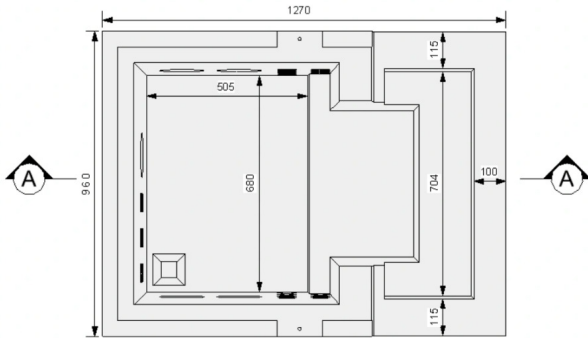

PLAN VIEW:

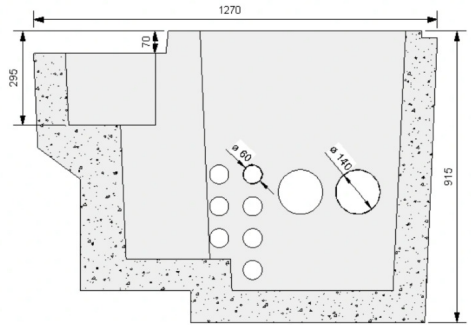

SECTION A-A:

CONFIDENCE IN CONCRETE™

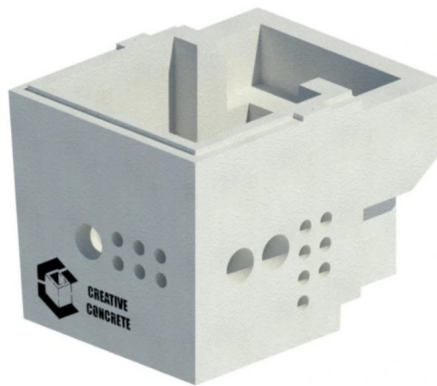

TECHNICAL DATA	
Mechanical Resistance	Vertical Strength 140kN
Weight	930KG
Opening Size	(LN x WN) 1070mm, 680mm Rectangular
Watertightness	No Leakage of joint or unit at 30kPa
Durability	Adequate for normal serviceability conditions

FEATURES	
Integrated Duct Openings	✓
Manufactured to the highest standards.	✓
Steel Reinforced	✓
Integrated Steps	
Integrated Lifting Sockets	✓
REV_05	

All Products are manufactured in compliance with EN 1917:2002&AC:2008 Concrete Manholes and Inspection Chambers Un-Reinforced, Steel, Fibre, And Reinforced. Profiles, sizes, weights are given as an indication only. The manufacturer reserves the right to modify these at any time without notice.

Concrete Chambers Ireland Ltd T/A Creative Concrete





CREATIVE CONCRETE
Innovation in concrete since 1999

VC 1 Cover & Frame

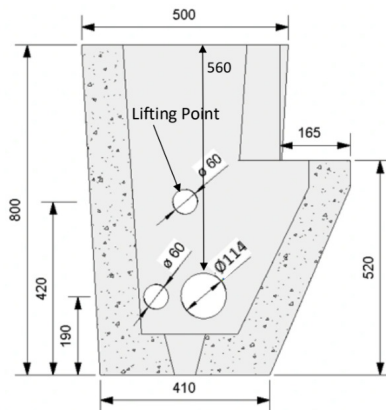
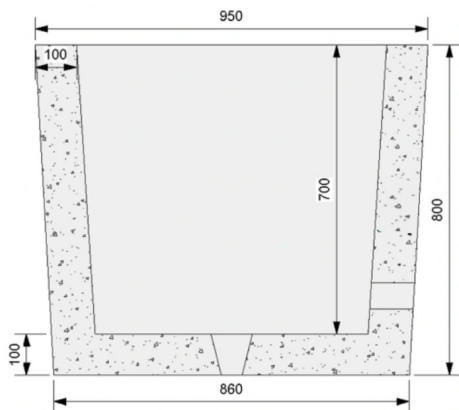

CONFIDENCE IN CONCRETE™

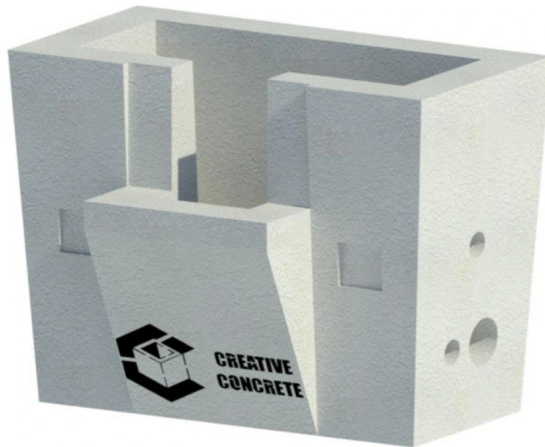

TECHNICAL DATA	
Mechanical Resistance	Vertical Strength 140kN
Weight	485KG
Opening Size	(LN x WN) 750mm, 300mm Rectangular
Watertightness	No Leakage of joint or unit at 30kPa
Durability	Adequate for normal serviceability conditions

FEATURES	
Integrated Duct Openings	✓
Manufactured to the highest standards.	✓
Steel Reinforced	✓
Integrated Steps	
Integrated Lifting Sockets	✓
REV_06	

All Products are manufactured in compliance with EN 1917:2002&AC:2008 Concrete Manholes and Inspection Chambers Un-Reinforced, Steel, Fibre, And Reinforced. Profiles, sizes, weights are given as an indication only. The manufacturer reserves the right to modify these at any time without notice.

Concrete Chambers Ireland Ltd T/A Creative Concrete



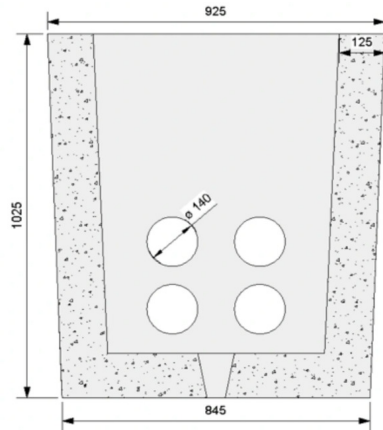
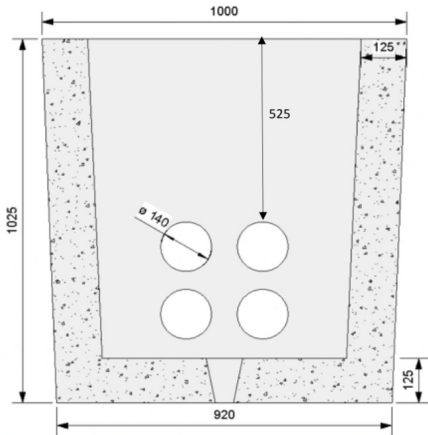

CONFIDENCE IN CONCRETE™

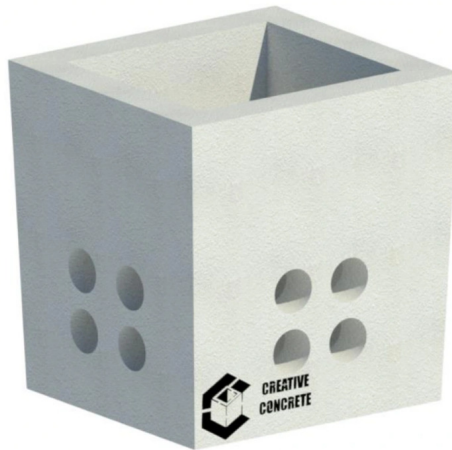

TECHNICAL DATA	
Mechanical Resistance	Vertical Strength 400kN
Approx Weight	1000KG
Opening Size	(LN x WN) 750mm, 675mm Rectangular
Watertightness	No Leakage of joint or unit at 30kPa
Durability	Adequate for normal serviceability conditions

FEATURES	
Integrated Duct Openings	✓
Manufactured to the highest standards.	✓
Steel Reinforced	✓
Integrated Lifting Sockets	
REV_05	

All Products are manufactured in compliance with EN 1917:2002&AC:2008 Concrete Manholes and Inspection Chambers Un-Reinforced, Steel, Fibre, And Reinforced. Profiles, sizes, weights are given as an indication only. The manufacturer reserves the right to modify these at any time without notice.

Concrete Chambers Ireland Ltd T/A Creative Concrete





CREATIVE CONCRETE
Innovation in concrete since 1999

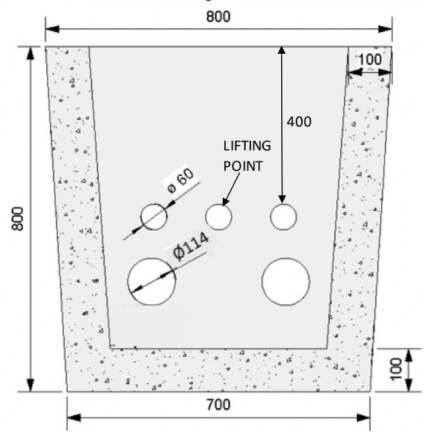
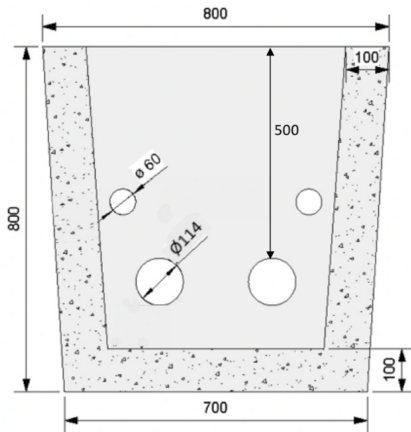

CONFIDENCE IN CONCRETE™



TECHNICAL DATA	
Mechanical Resistance	Vertical Strength 400kN
Approx Weight	530KG
Opening Size	(LN x WN) 600mm, 600mm Square
Watertightness	No Leakage of joint or unit at 30kPa
Durability	Adequate for normal serviceability conditions

FEATURES	
Integrated Duct Openings	✓
Manufactured to the highest standards.	✓
Steel Reinforced	
Integrated Steps	
Integrated Lifting Sockets	
REV_05	

All Products are manufactured in compliance with EN 1917:2002&AC:2008 Concrete Manholes and Inspection Chambers Un-Reinforced, Steel, Fibre, And Reinforced. Profiles, sizes, weights are given as an indication only. The manufacturer reserves the right to modify these at any time without notice.

Concrete Chambers Ireland Ltd T/A Creative Concrete





CREATIVE CONCRETE
Innovation in concrete since 1999

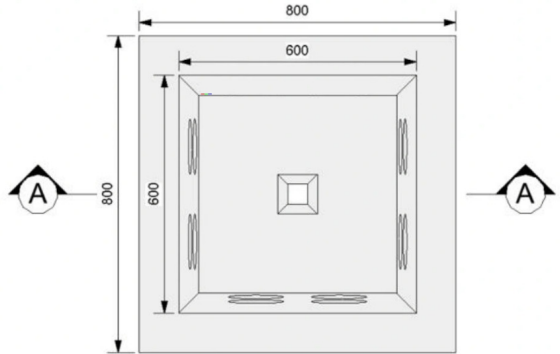
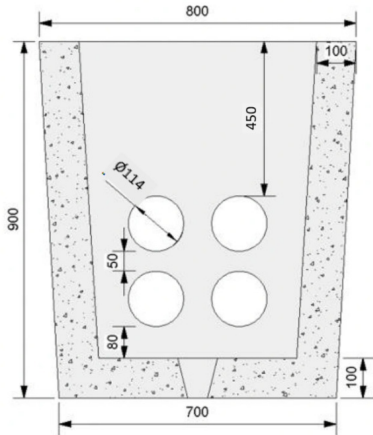

CONFIDENCE IN CONCRETE™

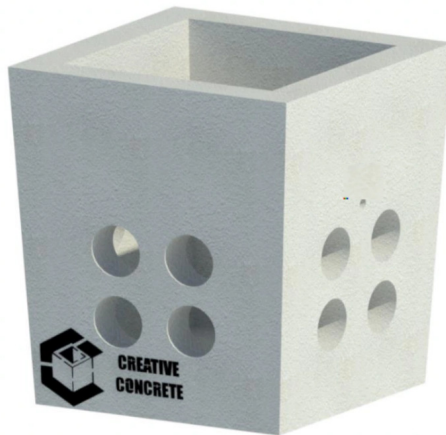

TECHNICAL DATA	
Mechanical Resistance	Vertical Strength 400kN
Approx Weight	615KG
Opening Size	(LN x WN) 600mm, 600mm Square
Watertightness	No Leakage of joint or unit at 30kPa
Durability	Adequate for normal serviceability conditions

FEATURES	
Integrated Duct Openings	✓
Manufactured to the highest standards.	✓
Steel Reinforced	✓
Integrated Steps	
Compatible with Universal Riser	✓
REV-05	

All Products are manufactured in compliance with EN 1917:2002&AC:2008 Concrete Manholes and Inspection Chambers Un-Reinforced, Steel, Fibre, And Reinforced. Profiles, sizes, weights are given as an indication only. The manufacturer reserves the right to modify these at any time without notice.

Concrete Chambers Ireland Ltd T/A Creative Concrete





CREATIVE CONCRETE
Innovation in concrete since 1999

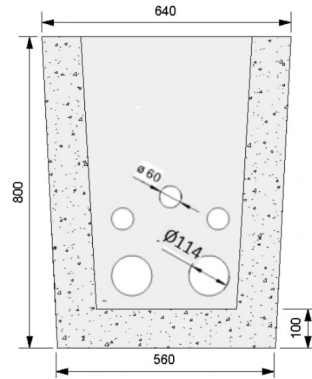
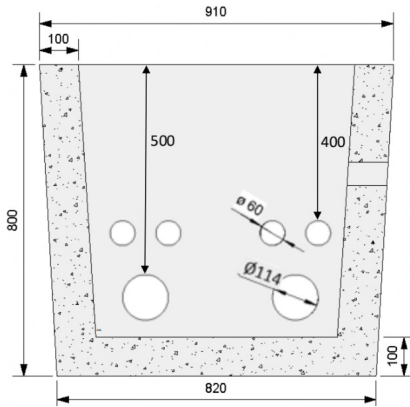

CONFIDENCE IN CONCRETE™

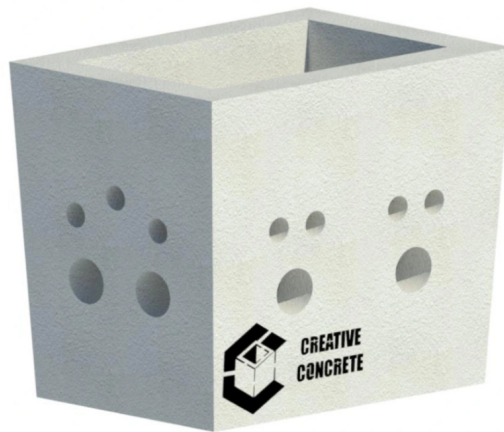

TECHNICAL DATA	
Mechanical Resistance	Vertical Strength 400kN
Approx Weight	490KG
Opening Size	(LN x WN) 710mm, 440mm Rectangular
Watertightness	No Leakage of joint or unit at 30kPa
Durability	Adequate for normal serviceability conditions

FEATURES	
Integrated Duct Openings	✓
Manufactured to the highest standards.	✓
Steel Reinforced	
Integrated Steps	
Integrated Lifting Sockets	
REV_05	

All Products are manufactured in compliance with EN 1917:2002&AC:2008 Concrete Manholes and Inspection Chambers Un-Reinforced, Steel, Fibre, And Reinforced. Profiles, sizes, weights are given as an indication only. The manufacturer reserves the right to modify these at any time without notice.

Concrete Chambers Ireland Ltd T/A Creative Concrete



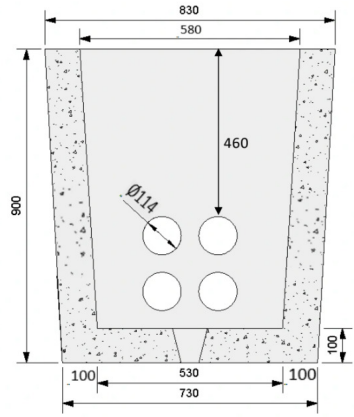
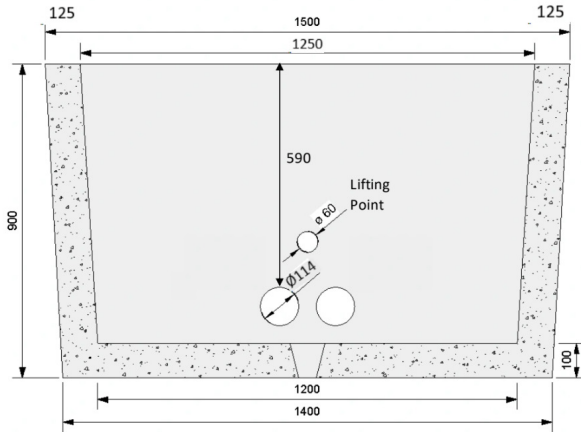

CONFIDENCE IN CONCRETE™

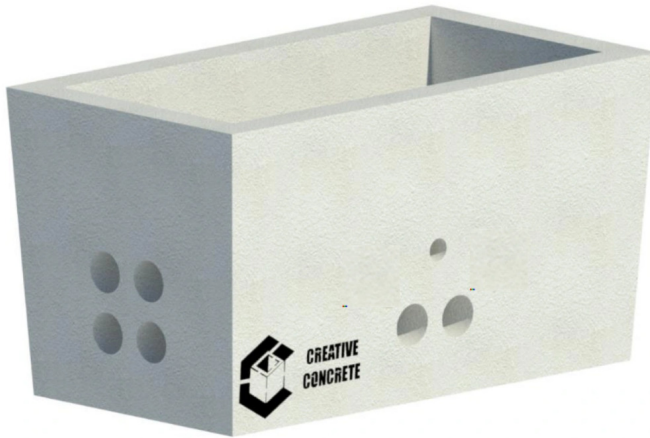

TECHNICAL DATA	
Mechanical Resistance	Vertical Strength 400kN
Approx Weight	950KG
Opening Size	(LN x WN) 1250mm, 580mm Rectangular
Watertightness	No Leakage of joint or unit at 30kPa
Durability	Adequate for normal serviceability conditions

FEATURES	
Integrated Duct Openings	✓
Manufactured to the highest standards.	✓
Steel Reinforced	
Integrated Steps	
Integrated Lifting Sockets	
REV_06	

All Products are manufactured in compliance with EN 1917:2002&AC:2008 Concrete Manholes and Inspection Chambers Un-Reinforced, Steel, Fibre, And Reinforced. Profiles, sizes, weights are given as an indication only. The manufacturer reserves the right to modify these at any time without notice.

Concrete Chambers Ireland Ltd T/A Creative Concrete





**CREATIVE
CONCRETE**
Innovation in concrete since 1999

June 2024 –Revision 5



CONCRETE CHAMBERS IRELAND LTD T/A CREATIVE CONCRETE
Ballynasrah, Ballinamere, Tullamore, Co. Offaly R35 P866
057 93 55808/087 2247270
info@creativeconcrete.ie www.creativeconcrete.ie





CREATIVE CONCRETE
Innovation in concrete since 1999

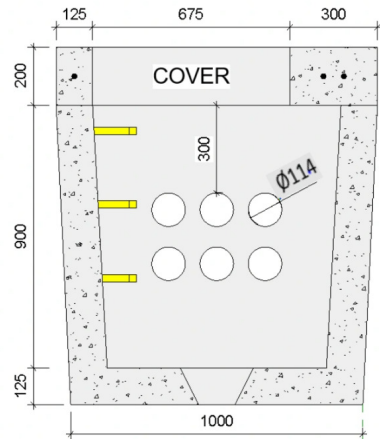
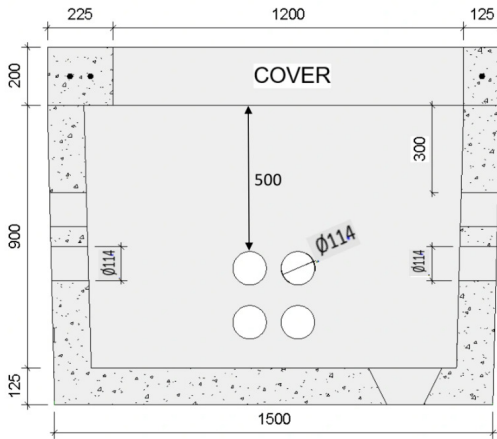

CONFIDENCE IN CONCRETE™

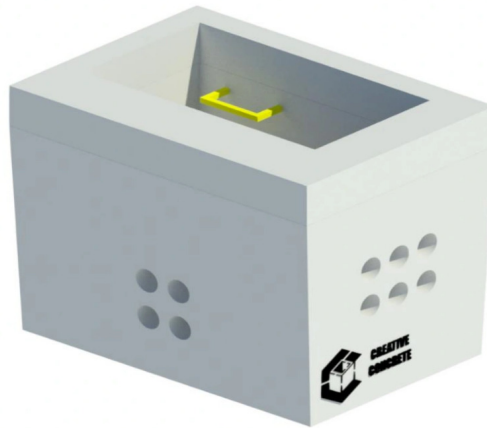

TECHNICAL DATA	
Mechanical Resistance	Vertical Strength 400kN
Chamber Approx Weight	1650KG
Cover Approx Weight	430KG
Chamber Opening Size	(LN x WN) 1300mm, 850mm Rectangular
Cover opening Size	(LN x WN) 1200mm, 675mm Rectangular
Watertightness	No Leakage of joint or unit at 30kPa
Durability	Adequate for normal serviceability conditions

FEATURES	
Integrated Duct Openings	✓
Manufactured to the highest standards.	✓
Steel Reinforced	✓
Integrated Steps	✓
Integrated Lifting Sockets	✓
REV_05	

All Products are manufactured in compliance with EN 1917:2002&AC:2008 Concrete Manholes and Inspection Chambers Un-Reinforced, Steel, Fibre, And Reinforced. Profiles, sizes, weights are given as an indication only. The manufacturer reserves the right to modify these at any time without notice.

Concrete Chambers Ireland Ltd T/A Creative Concrete



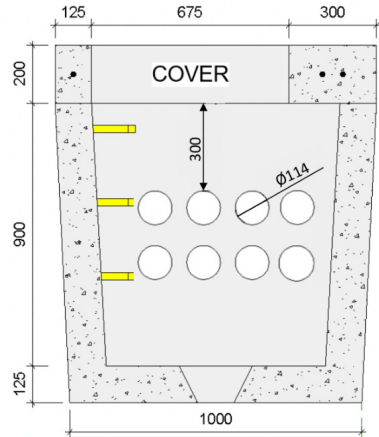
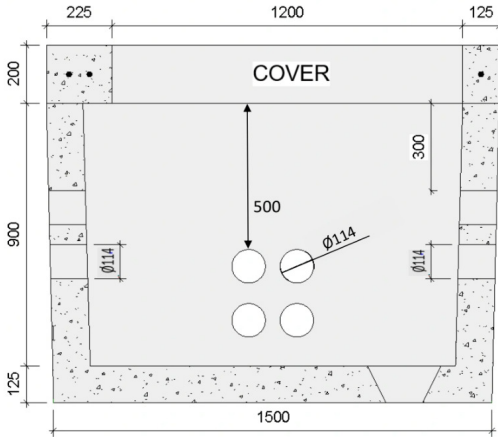

CONFIDENCE IN CONCRETE™

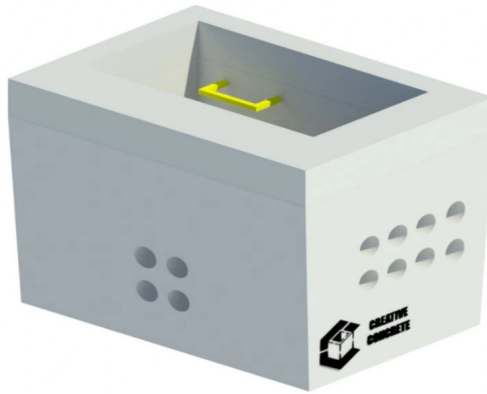

TECHNICAL DATA	
Mechanical Resistance	Vertical Strength 400kN
Chamber Approx Weight	1650KG
Cover Approx Weight	430KG
Chamber Opening Size	(LN x WN) 1300mm, 850mm Rectangular
Cover opening Size	(LN x WN) 1200mm, 675mm Rectangular
Watertightness	No Leakage of joint or unit at 30kPa
Durability	Adequate for normal serviceability conditions

FEATURES	
Integrated Duct Openings	✓
Manufactured to the highest standards.	✓
Steel Reinforced	✓
Integrated Steps	✓
Integrated Lifting Sockets	✓
REV_05	

All Products are manufactured in compliance with EN 1917:2002&AC:2008 Concrete Manholes and Inspection Chambers Un-Reinforced, Steel, Fibre, And Reinforced. Profiles, sizes, weights are given as an indication only. The manufacturer reserves the right to modify these at any time without notice.

Concrete Chambers Ireland Ltd T/A Creative Concrete





CREATIVE CONCRETE
Innovation in concrete since 1999

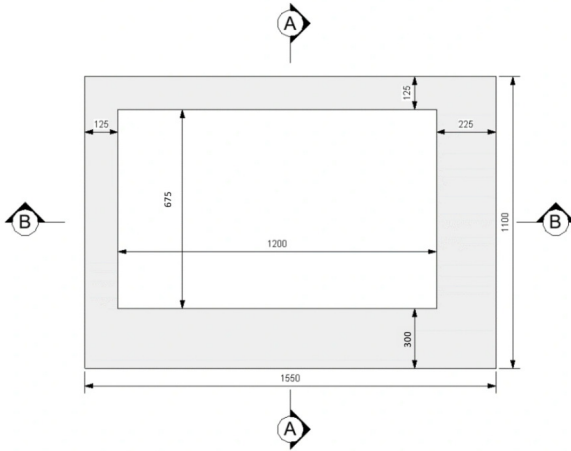

PLAN VIEW:

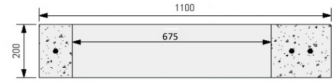

SECTION A-A:

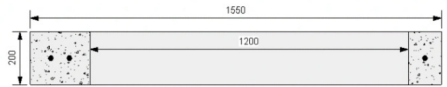

SECTION B-B:

CONFIDENCE IN CONCRETE™

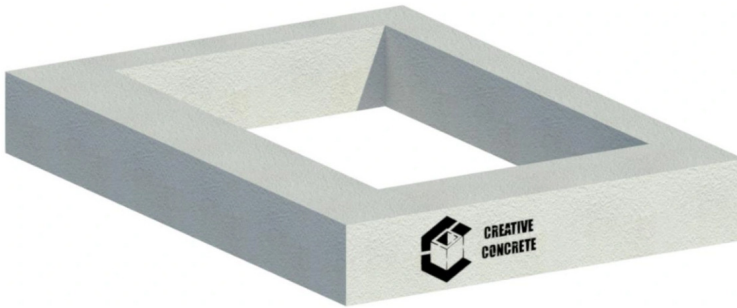

TECHNICAL DATA	
Mechanical Resistance	Vertical Strength 400kN
Chamber Approx Weight	430KG
Cover opening Size	(LN x WN) 1200mm, 675mm Rectangular
Watertightness	No Leakage of joint or unit at 30kPa
Durability	Adequate for normal serviceability conditions

FEATURES	
Integrated Duct Openings	✓
Manufactured to the highest standards.	✓
Steel Reinforced	✓
Integrated Steps	
Integrated Lifting Sockets	✓
REV_05	

All Products are manufactured in compliance with EN 1917:2002&AC:2008 Concrete Manholes and Inspection Chambers Un-Reinforced, Steel, Fibre, And Reinforced. Profiles, sizes, weights are given as an indication only. The manufacturer reserves the right to modify these at any time without notice.

Concrete Chambers Ireland Ltd T/A Creative Concrete



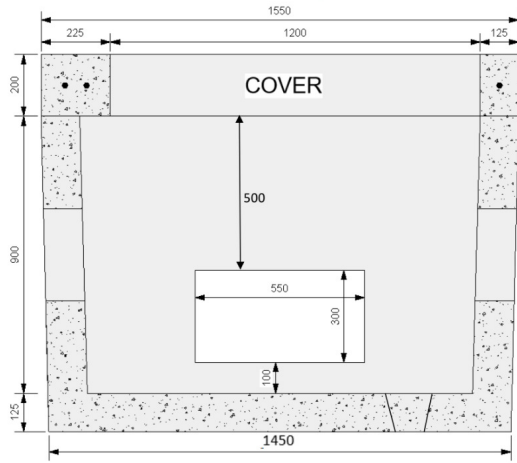
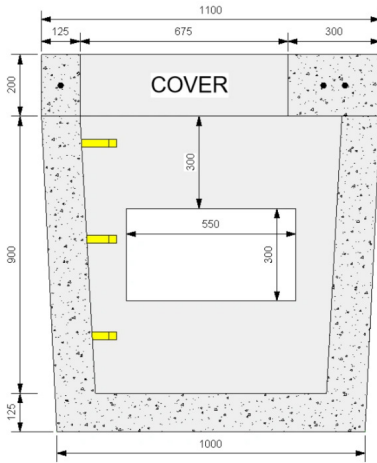

CONFIDENCE IN CONCRETE™

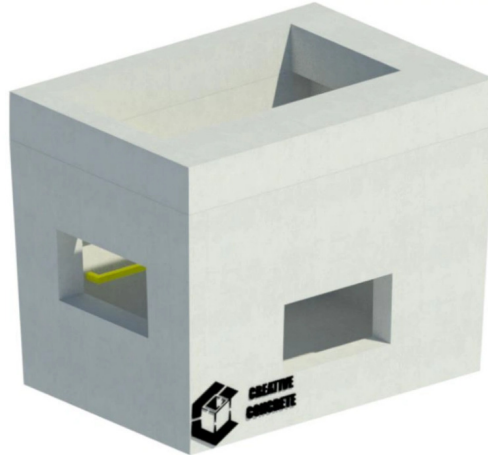

TECHNICAL DATA	
Mechanical Resistance	Vertical Strength 400kN
Chamber Approx Weight	1650KG
Cover Approx Weight	430KG
Chamber Opening Size	(LN x WN) 1300mm, 850mm Rectangular
Cover Opening Size	(LN x WN) 1200mm, 675mm Rectangular
Watertightness	No Leakage of joint or unit at 30kPa
Durability	Adequate for normal serviceability conditions

FEATURES	
Integrated Duct Openings	✓
Manufactured to the highest standards.	✓
Steel Reinforced	✓
Integrated Steps	✓
Integrated Lifting Sockets	✓
REV_05	

All Products are manufactured in compliance with EN 1917:2002&AC:2008 Concrete Manholes and Inspection Chambers Un-Reinforced, Steel, Fibre, And Reinforced. Profiles, sizes, weights are given as an indication only. The manufacturer reserves the right to modify these at any time without notice.

Concrete Chambers Ireland Ltd T/A Creative Concrete



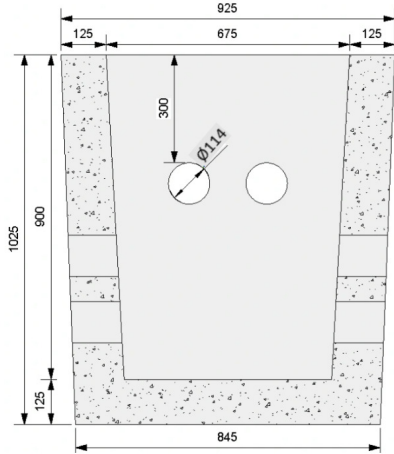
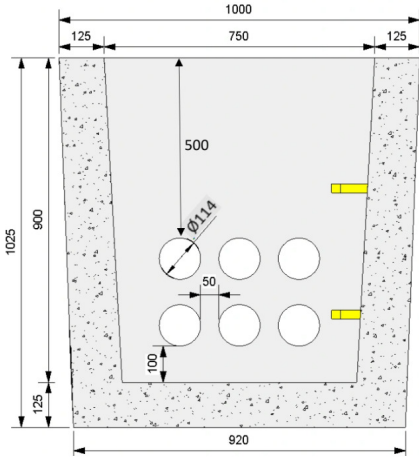

CONFIDENCE IN CONCRETE™

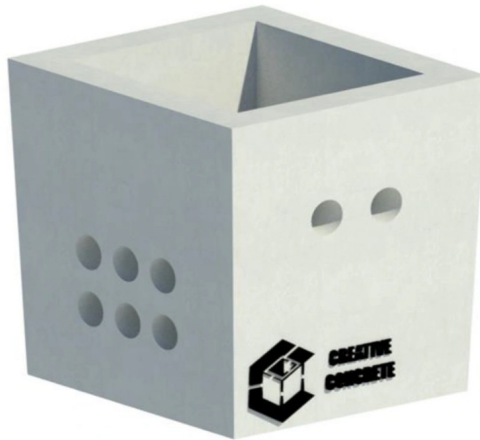

TECHNICAL DATA	
Mechanical Resistance	Vertical Strength 400kN
Approx Weight	1000KG
Opening Size	(LN x WN) 750mm, 675mm Rectangular
Watertightness	No Leakage of joint or unit at 30kPa
Durability	Adequate for normal serviceability conditions

FEATURES	
Integrated Duct Openings	✓
Manufactured to the highest standards.	✓
Steel Reinforced	✓
Integrated Steps	✓
Integrated Lifting Sockets	✓
REV_05	

All Products are manufactured in compliance with EN 1917:2002&AC:2008 Concrete Manholes and Inspection Chambers Un-Reinforced, Steel, Fibre, And Reinforced. Profiles, sizes, weights are given as an indication only. The manufacturer reserves the right to modify these at any time without notice.

Concrete Chambers Ireland Ltd T/A Creative Concrete





CREATIVE CONCRETE
Innovation in concrete since 1999

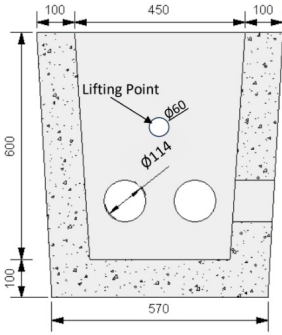

END ELEVATION

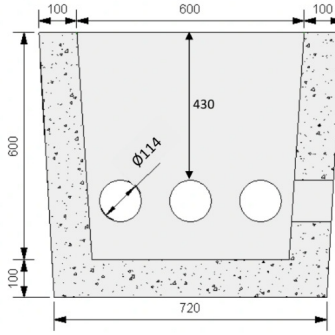

SIDE ELEVATION

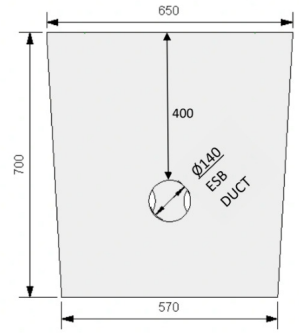

END ELEVATION

CONFIDENCE IN CONCRETE™

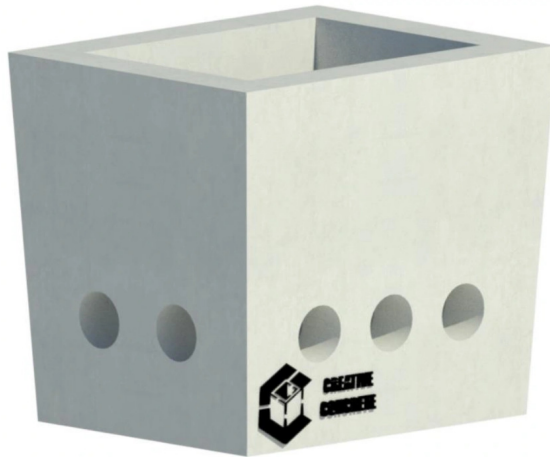

TECHNICAL DATA	
Mechanical Resistance	Vertical Strength 400kN
Approx Weight	500KG
Opening Size	(LN x WN) 600mm, 450mm Rectangular
Watertightness	No Leakage of joint or unit at 30kPa
Durability	Adequate for normal serviceability conditions

FEATURES	
Integrated Duct Openings	✓
Manufactured to the highest standards.	✓
Steel Reinforced	✓
Integrated Steps	
Integrated Lifting Sockets	
REV_05	

All Products are manufactured in compliance with EN 1917:2002&AC:2008 Concrete Manholes and Inspection Chambers Un-Reinforced, Steel, Fibre, And Reinforced. Profiles, sizes, weights are given as an indication only. The manufacturer reserves the right to modify these at any time without notice.

Concrete Chambers Ireland Ltd T/A Creative Concrete





CREATIVE CONCRETE

Innovation in concrete since 1999

CONFIDENCE IN CONCRETE™



Irish Construction
Excellence Awards **2024**
Winner

Ballinamere,
Tullamore, Co.Offaly.
057 93 55808

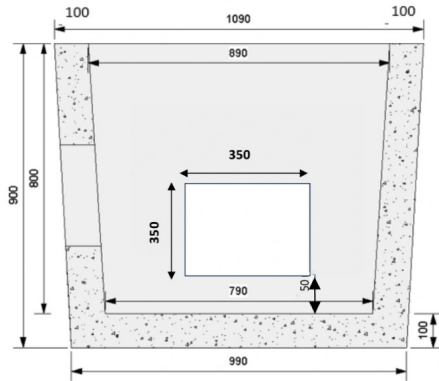
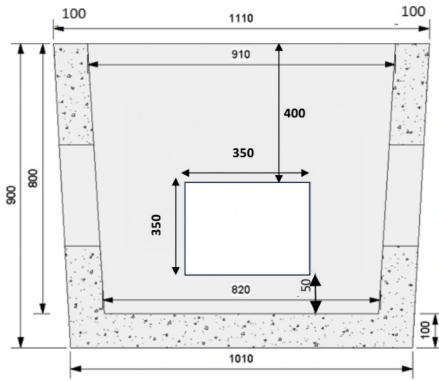

350 x 350 Letter Box OPE

CONFIDENCE IN CONCRETE™



TECHNICAL DATA	
Mechanical Resistance	Vertical Strength 400kN
Approx Weight	875KG
Opening Size	(LN x WN) 910mm, 890mm Rectangular
Watertightness	No Leakage of joint or unit at 30kPa
Durability	Adequate for normal serviceability conditions

FEATURES	
Integrated Valve Openings	✓
Manufactured to the highest standards.	✓
Steel Reinforced	✓
Integrated Steps	
Integrated Lifting Sockets	✓
REV_05	

All Products are manufactured in compliance with EN 1917:2002&AC:2008 Concrete Manholes and Inspection Chambers Un-Reinforced, Steel, Fibre, And Reinforced. The information contained in this TDS was up to date at time of going to print. Profiles, sizes, weights are given as an indication only. The manufacturer reserves the right to modify these at any time without notice.



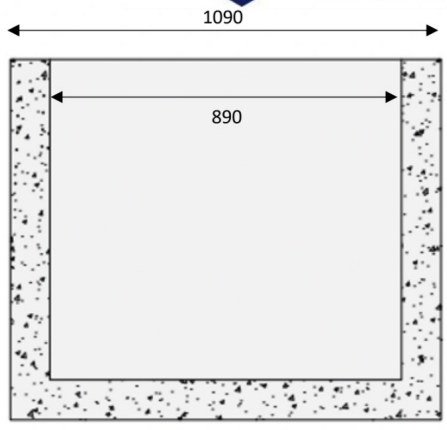
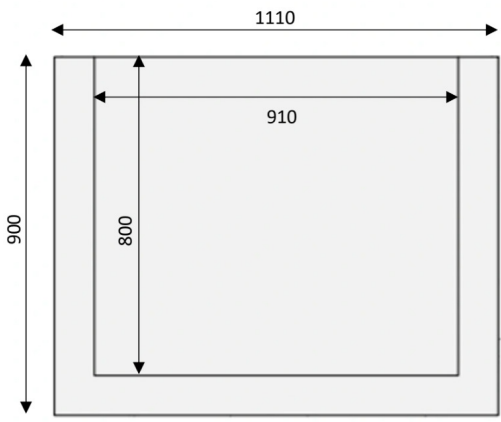

CONFIDENCE IN CONCRETE™

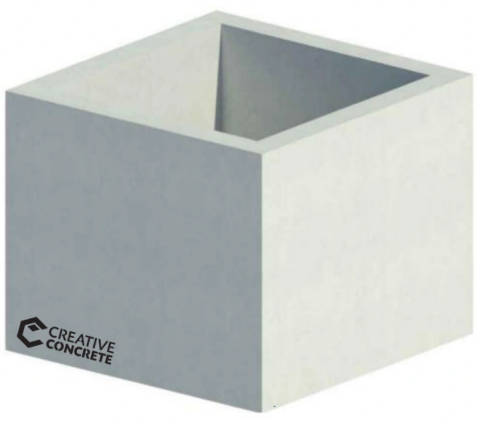

TECHNICAL DATA	
Mechanical Resistance	Vertical Strength 400kN
Weight	900KG
Opening Size	(LN x WN) 910mm, 890mm Rectangular
Watertightness	No Leakage of joint or unit at 30kPa
Durability	Adequate for normal serviceability conditions

FEATURES	
Integrated Valve Openings	
Manufactured to the highest standards.	✓
Steel Reinforced	✓
Integrated Steps	
Integrated Lifting pins	✓
REV_04	

All Products are manufactured in compliance with EN 1917:2002&AC:2008 Concrete Manholes and Inspection Chambers Un-Reinforced, Steel, Fibre, And Reinforced. The information contained in this TDS was up to date at time of going to print. Profiles, sizes, weights are given as an indication only. The manufacturer reserves the right to modify these at any time without notice.



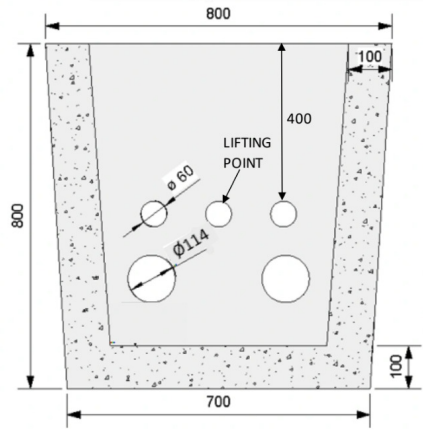
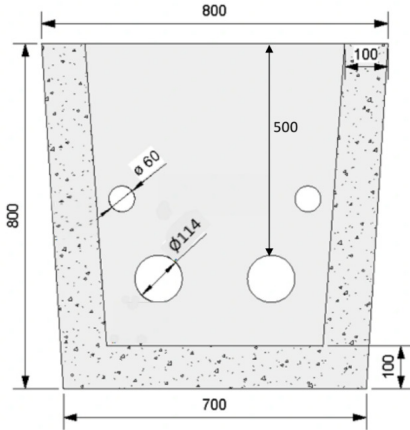

CONFIDENCE IN CONCRETE™



TECHNICAL DATA	
Mechanical Resistance	Vertical Strength 400kN
Approx Weight	530KG
Opening Size	(LN x WN) 600mm, 600mm Square
Watertightness	No Leakage of joint or unit at 30kPa
Durability	Adequate for normal serviceability conditions

FEATURES	
Integrated Duct Openings	✓
Manufactured to the highest standards.	✓
Steel Reinforced	
Integrated Steps	
Integrated Lifting Sockets	
REV_05	

All Products are manufactured in compliance with EN 1917:2002&AC:2008 Concrete Manholes and Inspection Chambers Un-Reinforced, Steel, Fibre, And Reinforced. Profiles, sizes, weights are given as an indication only. The manufacturer reserves the right to modify these at any time without notice.

Concrete Chambers Ireland Ltd T/A Creative Concrete



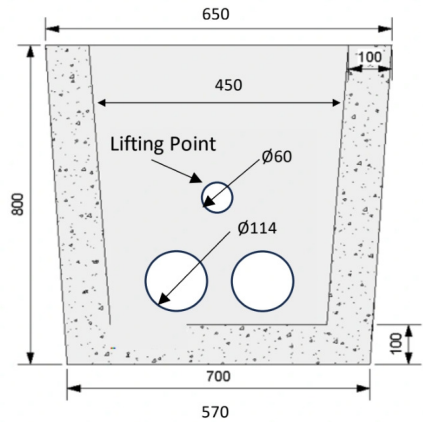
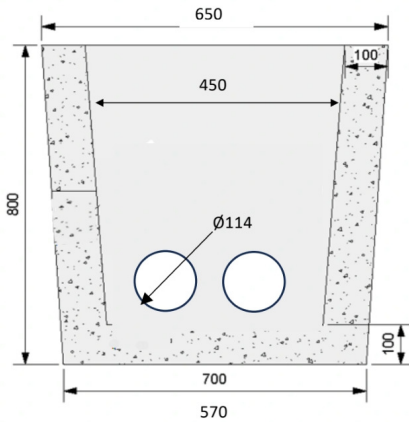

CONFIDENCE IN CONCRETE™



TECHNICAL DATA	
Mechanical Resistance	Vertical Strength 400kN
Approx Weight	425KG
Opening Size	(LN x WN) 450mm, 450mm Square
Watertightness	No Leakage of joint or unit at 30kPa
Durability	Adequate for normal serviceability conditions

FEATURES	
Integrated Duct Openings	✓
Manufactured to the highest standards.	✓
Steel Reinforced	
Integrated Steps	
Integrated Lifting Sockets	
REV_01	

All Products are manufactured in compliance with EN 1917:2002&AC:2008 Concrete Manholes and Inspection Chambers Un-Reinforced, Steel, Fibre, And Reinforced. Profiles, sizes, weights are given as an indication only. The manufacturer reserves the right to modify these at any time without notice.

Concrete Chambers Ireland Ltd T/A Creative Concrete





CREATIVE CONCRETE
Innovation in concrete since 1999

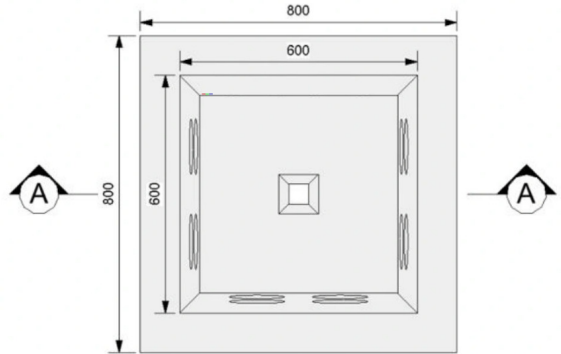
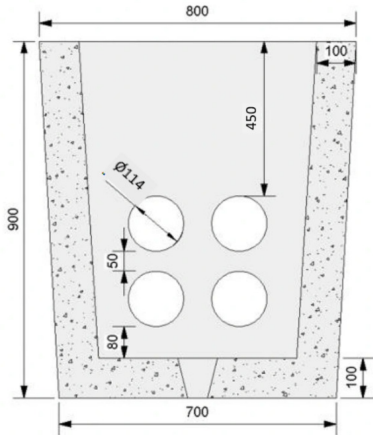

CONFIDENCE IN CONCRETE™

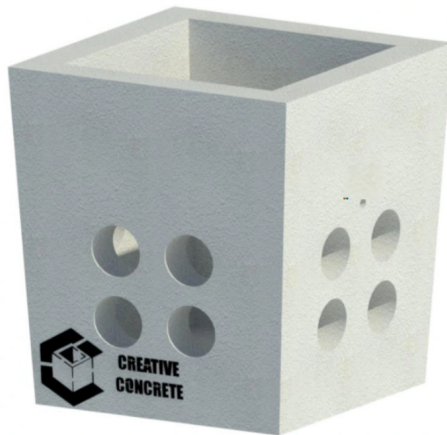

TECHNICAL DATA	
Mechanical Resistance	Vertical Strength 400kN
Approx Weight	615KG
Opening Size	(LN x WN) 600mm, 600mm Square
Watertightness	No Leakage of joint or unit at 30kPa
Durability	Adequate for normal serviceability conditions

FEATURES	
Integrated Duct Openings	✓
Manufactured to the highest standards.	✓
Steel Reinforced	✓
Integrated Steps	
Compatible with Universal Riser	✓
REV-05	

All Products are manufactured in compliance with EN 1917:2002&AC:2008 Concrete Manholes and Inspection Chambers Un-Reinforced, Steel, Fibre, And Reinforced. Profiles, sizes, weights are given as an indication only. The manufacturer reserves the right to modify these at any time without notice.

Concrete Chambers Ireland Ltd T/A Creative Concrete





**CREATIVE
CONCRETE**
Innovation in concrete since 1999

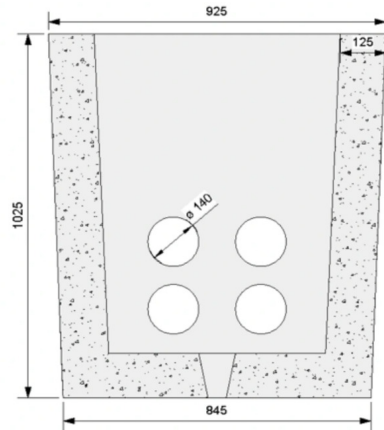
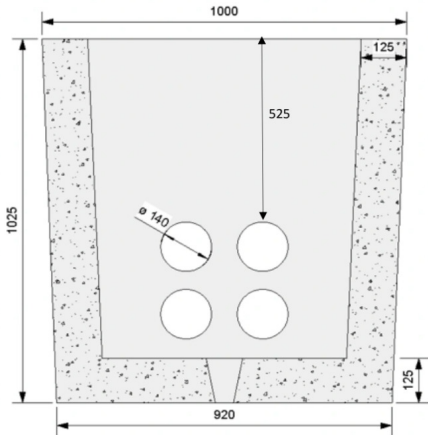

CONFIDENCE IN CONCRETE™

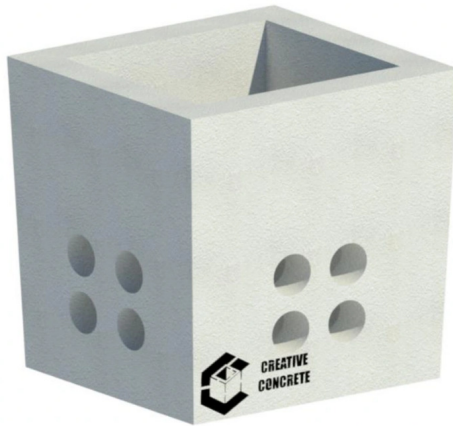

TECHNICAL DATA	
Mechanical Resistance	Vertical Strength 400kN
Approx Weight	1000KG
Opening Size	(LN x WN) 750mm, 675mm Rectangular
Watertightness	No Leakage of joint or unit at 30kPa
Durability	Adequate for normal serviceability conditions

FEATURES	
Integrated Duct Openings	✓
Manufactured to the highest standards.	✓
Steel Reinforced	✓
Integrated Lifting Sockets	
REV_05	

All Products are manufactured in compliance with EN 1917:2002&AC:2008 Concrete Manholes and Inspection Chambers Un-Reinforced, Steel, Fibre, And Reinforced. Profiles, sizes, weights are given as an indication only. The manufacturer reserves the right to modify these at any time without notice.

Concrete Chambers Ireland Ltd T/A Creative Concrete



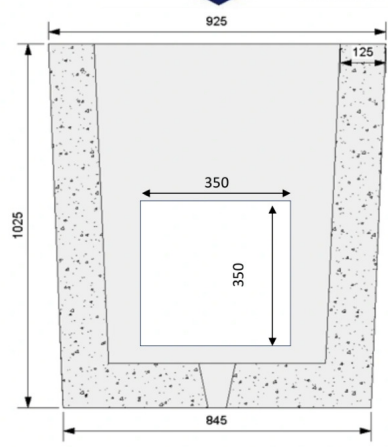
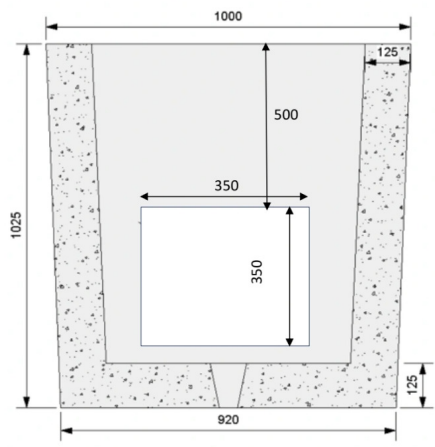

CONFIDENCE IN CONCRETE™

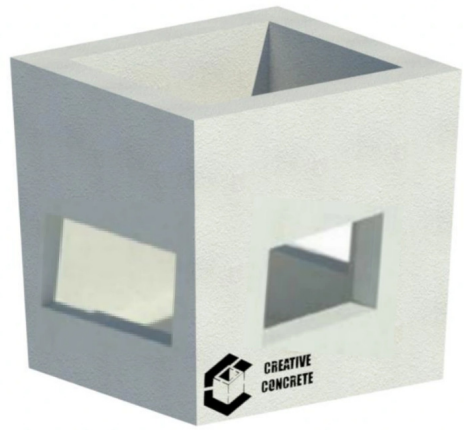

TECHNICAL DATA	
Mechanical Resistance	Vertical Strength 400kN
Approx Weight	1000KG
Opening Size	(LN x WN) 750mm, 675mm Rectangular
Watertightness	No Leakage of joint or unit at 30kPa
Durability	Adequate for normal serviceability conditions

FEATURES	
Integrated Duct Openings	✓
Manufactured to the highest standards.	✓
Steel Reinforced	✓
Openings can be easily knocked out on site	
REV_05	

All Products are manufactured in compliance with EN 1917:2002&AC:2008 Concrete Manholes and Inspection Chambers Un-Reinforced, Steel, Fibre, And Reinforced. Profiles, sizes, weights are given as an indication only. The manufacturer reserves the right to modify these at any time without notice.
 Concrete Chambers Ireland Ltd T/A Creative Concrete



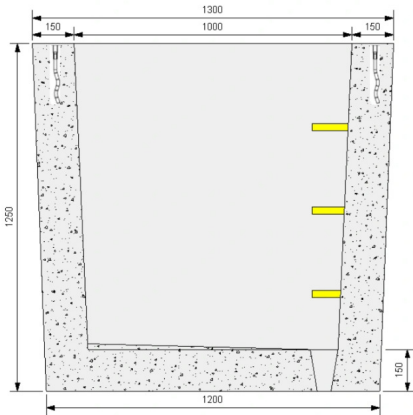

SECTION VIEW A-A:

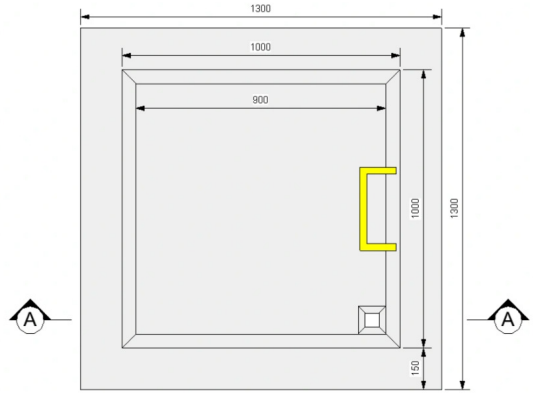

PLAN VIEW:

CONFIDENCE IN CONCRETE™

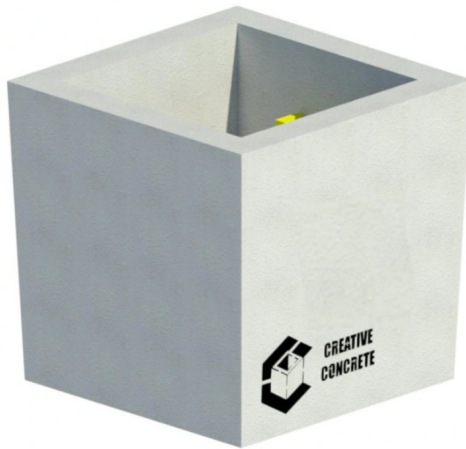

TECHNICAL DATA	
Mechanical Resistance	Vertical Strength 400kN
Weight	2450KG
Opening Size	(LN x WN) 1000mm x 1000mm Square
Watertightness	No Leakage of joint or unit at 30kPa
Durability	Adequate for normal serviceability conditions

FEATURES	
Integrated Duct Openings x 2	✓
Manufactured to the highest standards.	✓
Steel Reinforced	✓
Integrated Steps	✓
Integrated Lifting pins x 4	✓
REV_04	

All Products are manufactured in compliance with EN 1917:2002&AC:2008 Concrete Manholes and Inspection Chambers Un-Reinforced, Steel, Fibre, And Reinforced. The information contained in this TDS was up to date at time of going to print. Profiles, sizes, weights are given as an indication only. The manufacturer reserves the right to modify these at any time without notice.





CREATIVE CONCRETE
Innovation in concrete since 1999

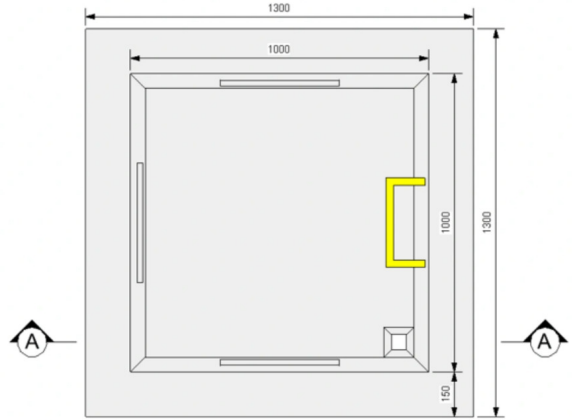
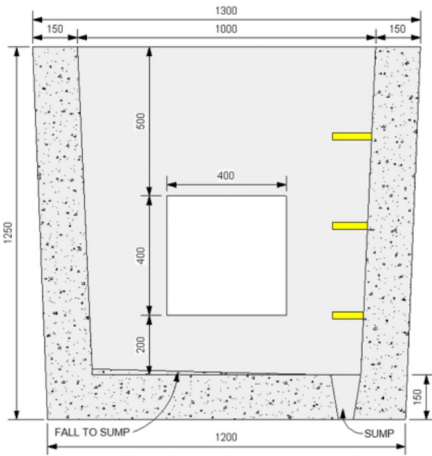

CONFIDENCE IN CONCRETE™

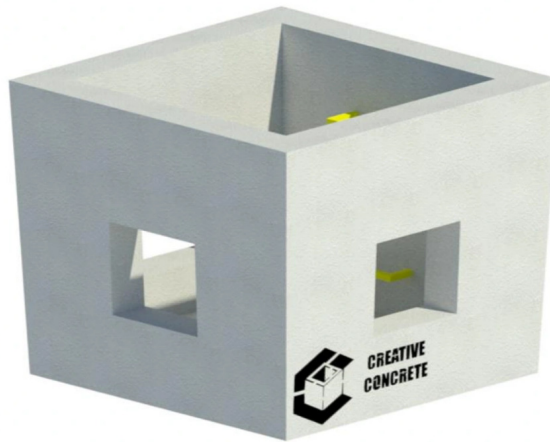

TECHNICAL DATA	
Mechanical Resistance	Vertical Strength 400kN
Approx Weight	2450KG
Opening Size	(LN x WN)1000mm, 1000mm Square
Watertightness	No Leakage of joint or unit at 30kPa
Durability	Adequate for normal serviceability conditions

FEATURES	
Integrated Duct Openings	✓
Manufactured to the highest standards.	✓
Steel Reinforced	✓
Integrated Steps	✓
Integrated Lifting Sockets	✓
REV_05	

All Products are manufactured in compliance with EN 1917:2002&AC:2008 Concrete Manholes and Inspection Chambers Un-Reinforced, Steel, Fibre, And Reinforced. Profiles, sizes, weights are given as an indication only. The manufacturer reserves the right to modify these at any time without notice.

Concrete Chambers Ireland Ltd T/A Creative Concrete



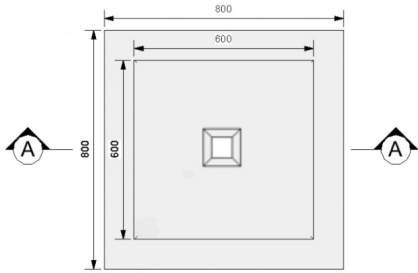

PLAN VIEW:

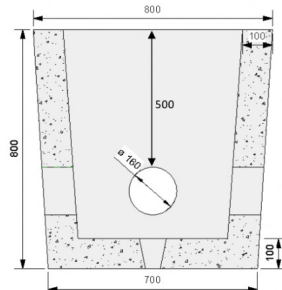

SECTION VIEW A-A:

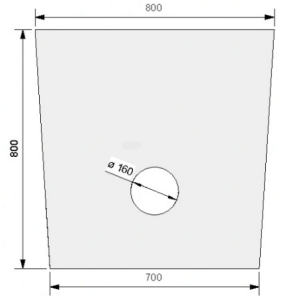

END ELEVATION:

CONFIDENCE IN CONCRETE™

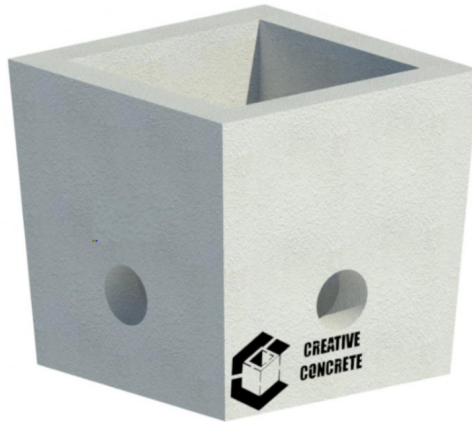

TECHNICAL DATA	
Mechanical Resistance	Vertical Strength 400kN
Approx Weight	530KG
Opening Size	(LN x WN) 600mm, 600mm Square
Watertightness	No Leakage of joint or unit at 30kPa
Durability	Adequate for normal serviceability conditions

FEATURES	
Integrated Duct Openings	✓
Manufactured to the highest standards.	✓
Steel Reinforced	✓
Integrated Steps	
Compatible with Universal Riser	✓
REV_05	

All Products are manufactured in compliance with EN 1917:2002&AC:2008 Concrete Manholes and Inspection Chambers Un-Reinforced, Steel, Fibre, And Reinforced. Profiles, sizes, weights are given as an indication only. The manufacturer reserves the right to modify these at any time without notice.

Concrete Chambers Ireland Ltd T/A Creative Concrete



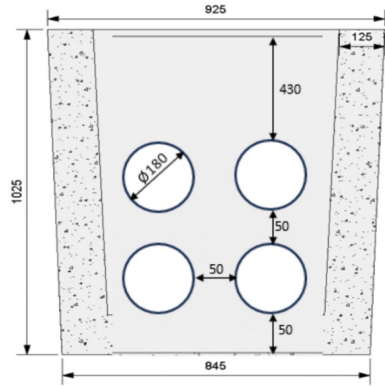
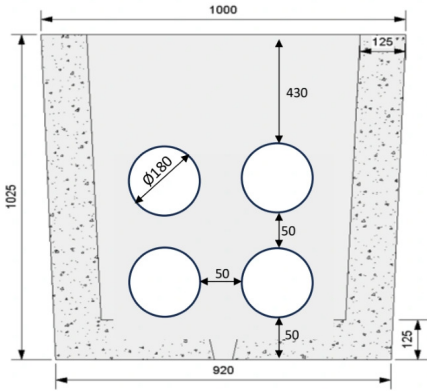

CONFIDENCE IN CONCRETE™

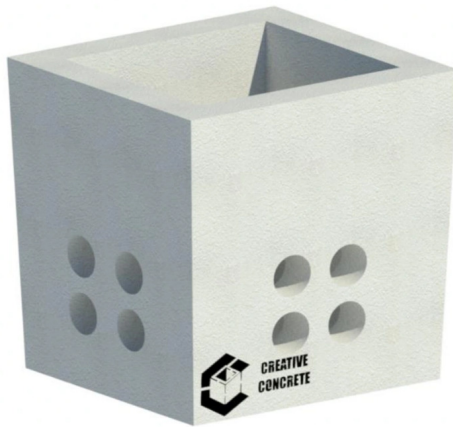

TECHNICAL DATA	
Mechanical Resistance	Vertical Strength 400kN
Approx Weight	1000KG
Opening Size	(LN x WN) 750mm, 675mm Rectangular
Watertightness	No Leakage of joint or unit at 30kPa
Durability	Adequate for normal serviceability conditions

FEATURES	
Integrated Duct Openings	✓
Manufactured to the highest standards.	✓
Steel Reinforced	✓
Integrated Lifting Sockets	
REV_01	

All Products are manufactured in compliance with EN 1917:2002&AC:2008 Concrete Manholes and Inspection Chambers Un-Reinforced, Steel, Fibre, And Reinforced. Profiles, sizes, weights are given as an indication only. The manufacturer reserves the right to modify these at any time without notice.

Concrete Chambers Ireland Ltd T/A Creative Concrete



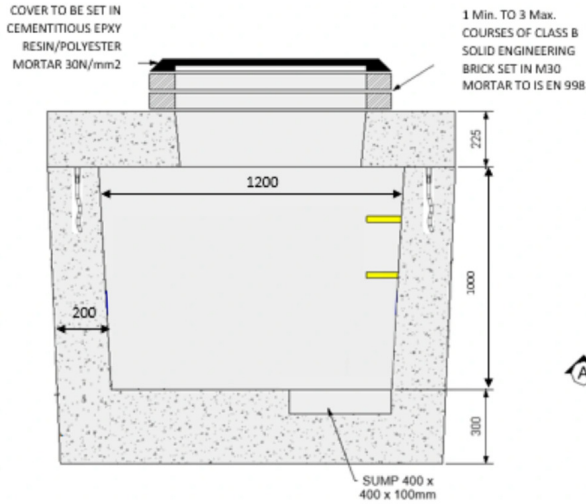

CONFIDENCE IN CONCRETE™

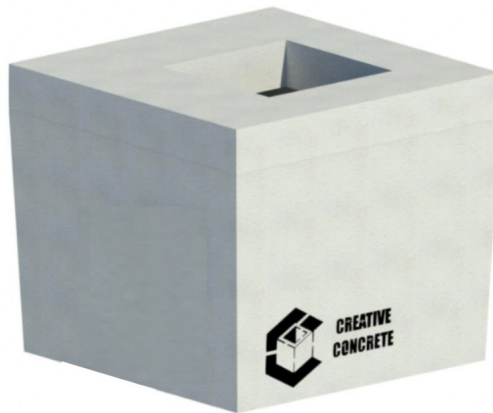

TECHNICAL DATA	
Mechanical Resistance	Vertical Strength 400kN
Approx Chamber Weight	4190KG
Approx Cover Weight	1140KG
Opening Size	(LN x WN) 1200mm, 1200mm Square
Watertightness	No Leakage of joint or unit at 30kPa
Durability	Adequate for normal serviceability conditions
Rev_05	

FEATURES	
Integrated Duct Openings	
Manufactured to the highest standards.	✓
Steel Reinforced	✓
Integrated Steps	✓
4 Integrated Lifting Sockets	✓

All Products are manufactured in compliance with EN 1917:2002&AC:2008 Concrete Manholes and Inspection Chambers Un-Reinforced, Steel, Fibre, And Reinforced. Profiles, sizes, weights are given as an indication only. The manufacturer reserves the right to modify these at any time without notice.

Concrete Chambers Ireland Ltd T/A Creative Concrete





COVER TO BE SET IN
CEMENTITIOUS EPXY
RESIN/POLYESTER
MORTAR 30N/mm²

1 Min. TO 3 Max.
COURSES OF CLASS
SOLID ENGINEERING
BRICK SET IN M30
MORTAR TO IS EN 998

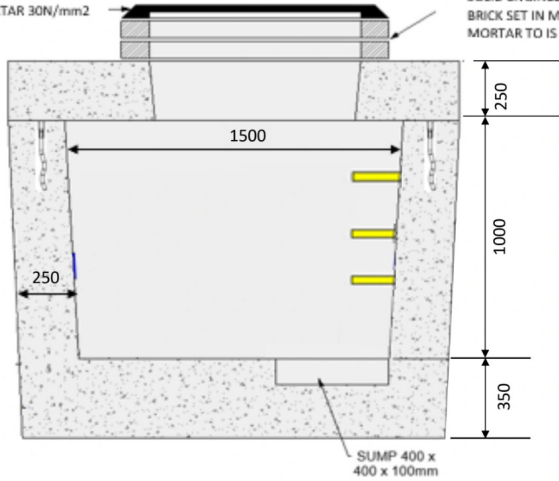

CONFIDENCE IN CONCRETE™

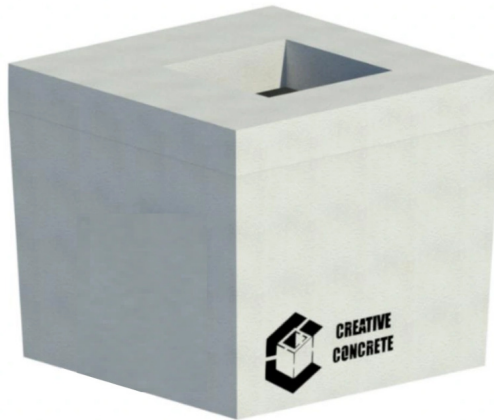

TECHNICAL DATA	
Mechanical Resistance	Vertical Strength 400kN
Approx Chamber Weight	7700KG
Approx Cover Weight	1900KG
Opening Size	(LN x WN) 1500mm, 1500mm Square
Watertightness	No Leakage of joint or unit at 30kPa
Durability	Adequate for normal serviceability conditions
Rev_05	

FEATURES	
Integrated Duct Openings	
Manufactured to the highest standards.	✓
Steel Reinforced	✓
Integrated Steps	
4 Integrated Lifting Sockets	✓

All Products are manufactured in compliance with EN 1917:2002&AC:2008 Concrete Manholes and Inspection Chambers Un-Reinforced, Steel, Fibre, And Reinforced. Profiles, sizes, weights are given as an indication only. The manufacturer reserves the right to modify these at any time without notice.

Concrete Chambers Ireland Ltd T/A Creative Concrete



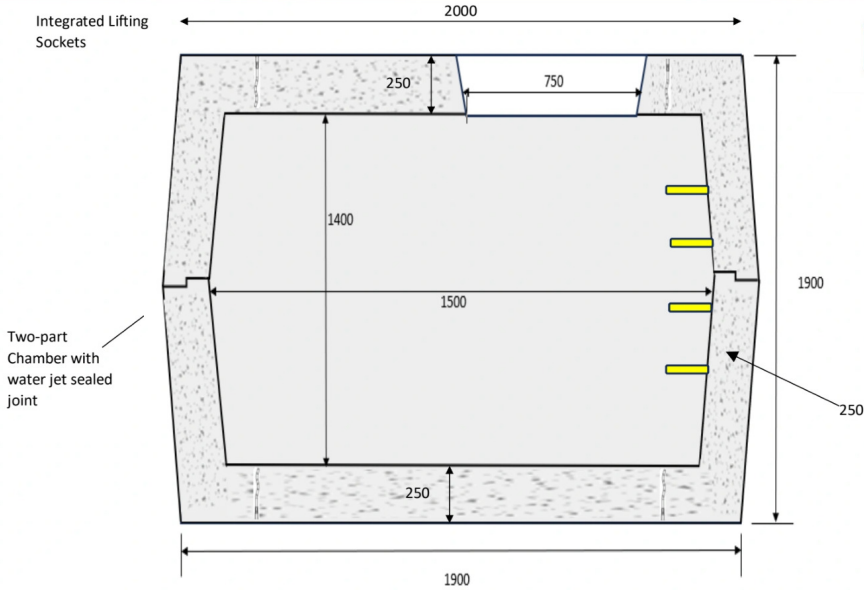

CONFIDENCE IN CONCRETE™

PLAN VIEW

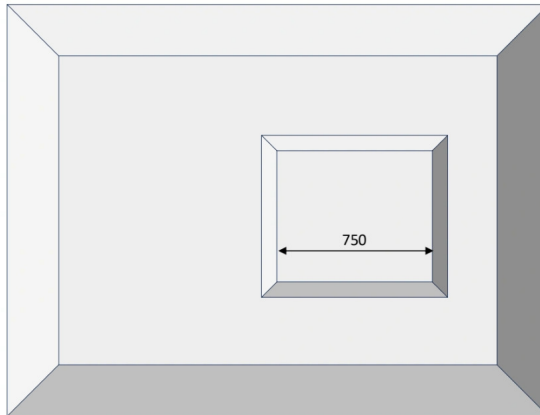

TECHNICAL DATA

Mechanical Resistance	Vertical Strength 400kN
Approx Weight	2 units (Bottom 4850) (Top 4650)
Opening Size	(LN x WN) 750mm, 750mm Square
Watertightness	No Leakage of joint or unit at 30kPa
Durability	Adequate for normal serviceability conditions
Opening Option	Opening available in 900 x 900 Square

FEATURES

Integrated Opening	✓
Manufactured to the highest standards.	✓
Steel Reinforced	✓
Integrated Steps	✓
Integrated Lifting Sockets	✓
REV_06	

All Products are manufactured in compliance with EN 1917:2002&AC:2008 Concrete Manholes and Inspection Chambers Un-Reinforced, Steel, Fibre, And Reinforced. Profiles, sizes, weights are given as an indication only. The manufacturer reserves the right to modify these at any time without notice.

Concrete Chambers Ireland Ltd T/A Creative Concrete





Installation Video



CREATIVE CONCRETE
Innovation in concrete since 1999

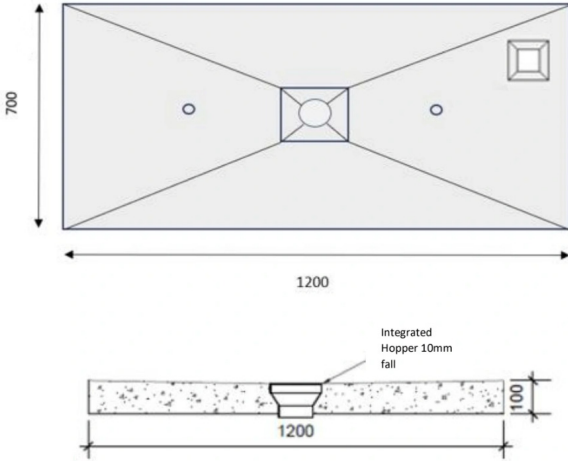

CONFIDENCE IN CONCRETE™

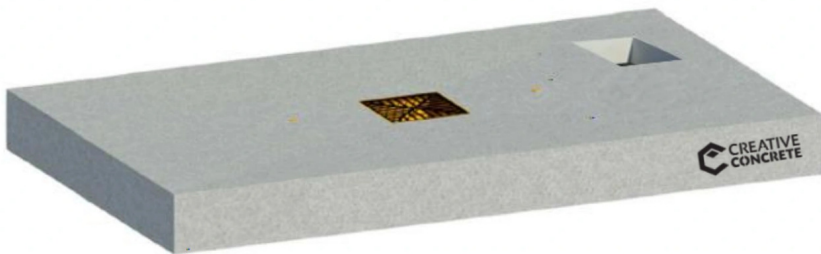

TECHNICAL DATA	
Mechanical Resistance	Vertical Strength 400kN
Weight	160KG
Opening Size	(LN x WN)160mm, 160mm Square
Watertightness	No Leakage of joint or unit at 30kPa
Durability	Adequate for normal serviceability conditions

FEATURES	
Integrated Opening	✓
Manufactured to the highest standards.	✓
Steel Reinforced	✓
Integrated Lifting Sockets	✓
REV_06	

All Products are manufactured in compliance with EN 1917:2002&AC:2008 Concrete Manholes and Inspection Chambers Un-Reinforced, Steel, Fibre, And Reinforced. Profiles, sizes, weights are given as an indication only. The manufacturer reserves the right to modify these at any time without notice.

Concrete Chambers Ireland Ltd T/A Creative Concrete



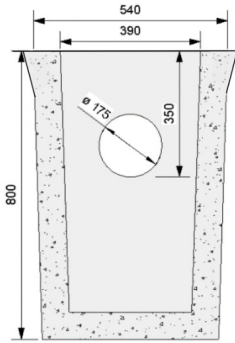

SECTION VIEW A-A:

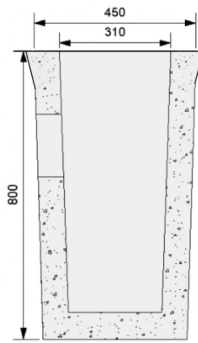

SECTION VIEW B-B:

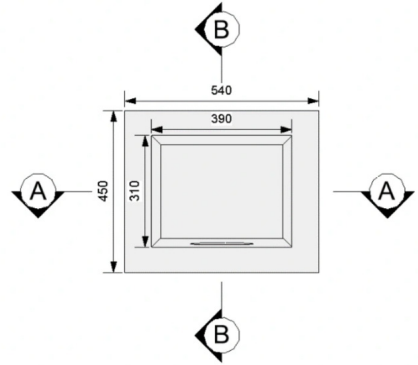

PLAN VIEW:

CONFIDENCE IN CONCRETE™



TECHNICAL DATA	
Mechanical Resistance	Vertical Strength 400kN
Weight	280KG
Opening Size	(LN x WN) 390mm, 310mm Rectangular
Watertightness	No Leakage of joint or unit at 30kPa
Durability	Adequate for normal serviceability conditions

FEATURES	
Integrated Duct Openings	
Manufactured to the highest standards.	✓
Steel Reinforced	
Integrated Steps	
Integrated Lifting pins	
REV_03	

All Products are manufactured in compliance with EN 1917:2002&AC:2008 Concrete Manholes and Inspection Chambers Un-Reinforced, Steel, Fibre, And Reinforced. The information contained in this TDS was up to date at time of going to print. Profiles, sizes, weights are given as an indication only. The manufacturer reserves the right to modify these at any time without notice.





CREATIVE CONCRETE
Innovation in concrete since 1999

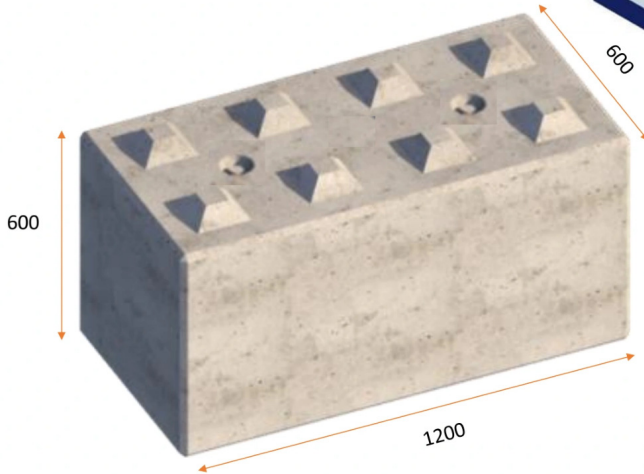

CONFIDENCE IN CONCRETE™



TECHNICAL DATA	
Mechanical Resistance	Vertical Strength 400kN
Approx Weight	1000KG
Watertightness	No Leakage of joint or unit at 30kPa
Durability	Adequate for normal serviceability conditions

FEATURES	
Manufactured to the highest standards.	
Steel Reinforced	
Integrated Lifting Pins	✓
REV-05	

All Products are manufactured in compliance with EN 1917:2002&AC:2008 Concrete Manholes and Inspection Chambers Un-Reinforced, Steel, Fibre, And Reinforced. Profiles, sizes, weights are given as an indication only. The manufacturer reserves the right to modify these at any time without notice.

Concrete Chambers Ireland Ltd T/A Creative Concrete





**CREATIVE
CONCRETE**

Innovation in concrete since 1999

**PRECAST UTILITY
CHAMBERS**

**BULK
WATER METER
CHAMBER
STD-W-26**

**An Innovative
Readymade Solution**

SCAN FOR VIDEO



057 93 55808

Tullamore, Co. Offaly

**info@creativeconcrete.ie
WWW.CREATIVECONCRETE.IE**



**Irish Construction
Excellence Awards 2024
Winner**



**CREATIVE
CONCRETE**
Innovation in concrete since 1999

June 2024 --Revision 5



CONCRETE CHAMBERS IRELAND LTD T/A CREATIVE CONCRETE

Ballynasrah, Ballinamere, Tullamore, Co. Offaly R35 P866

057 93 55808/087 2247270

info@creativeconcrete.ie www.creativeconcrete.ie

